

e-flex
smt
microsystems

Board Handling

Electronic Manufacturing Equipment

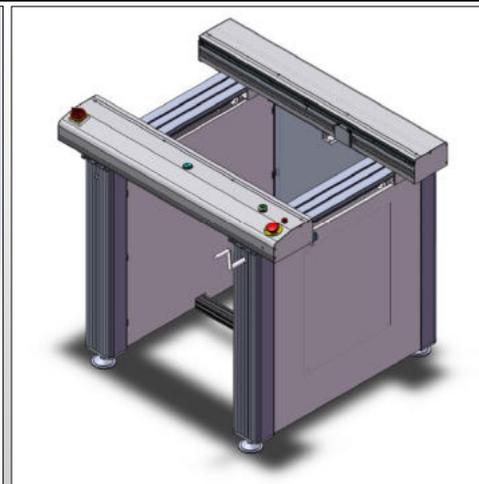
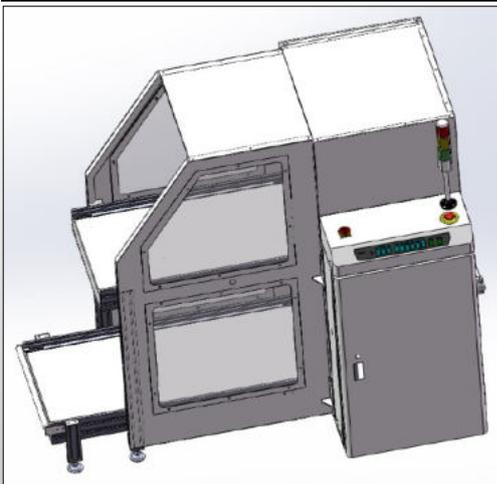

LOADERS/UNLOADERS

CONVEYORS

INVERTERS

BUFFERS

PLUS MANY OTHERS...



Enterprise Mission

Enterprise Core Values

Business Management Concept

Quality Management Concept

Contents

About us	01/02
Process	03
Assembly shop	04
Inspection & Linking Conveyors	05-08
Reject Conveyor	09
Flash off Conveyor	10
UV Stations	11/12
Manual Lifting Gate Conveyor	13
Lowering Gate Conveyor	14
Shuttle Conveyor	15
Telescopic Gate Conveyor	16
Multi-Function Magazine Buffer	17
Multi-Function Vertical Buffer	18
LIFO Vertical Buffer	19
NG/OK Vertical Buffer	20
Double buffers	21/22
Heavy-Duty and Curing Buffers	23/24
Turn Conveyor	25
PCB Inverters	26/27
Loader/Destacker Combo Machine	28
Vacuum Bear Board Loader	29
Destacker / Push-up Stacker	30
Vacuum Loader for LED Lights	31
Unloader for LED Lights	32
Multi Magazine Loader/Unloader	33
Mini Magazine Loader/Unloader	34
Single magazine Loader	35
Single Magazine Unloader	36
90 Degrees Unloader	37
Curing Loader	38
Compact Magazine Loader & Unloader	39/40
NG/OK Unloader / Dual Magazine Unloader	41
Elevator Conveyors / Return Lines	42
Insertion Conveyor	43
Flat Belt Conveyor	44
PCB Cleaning Machine	45
Wave Outfeed Conveyor	46
Laser Marker	47/48
Barcode Scanner Conveyor	49
Solder Ball Cleaning Machine	50
Automation Lines Examples	51
Customers World Wide	52
Quality Assurance & Agent Network	53
After-sale Service	54

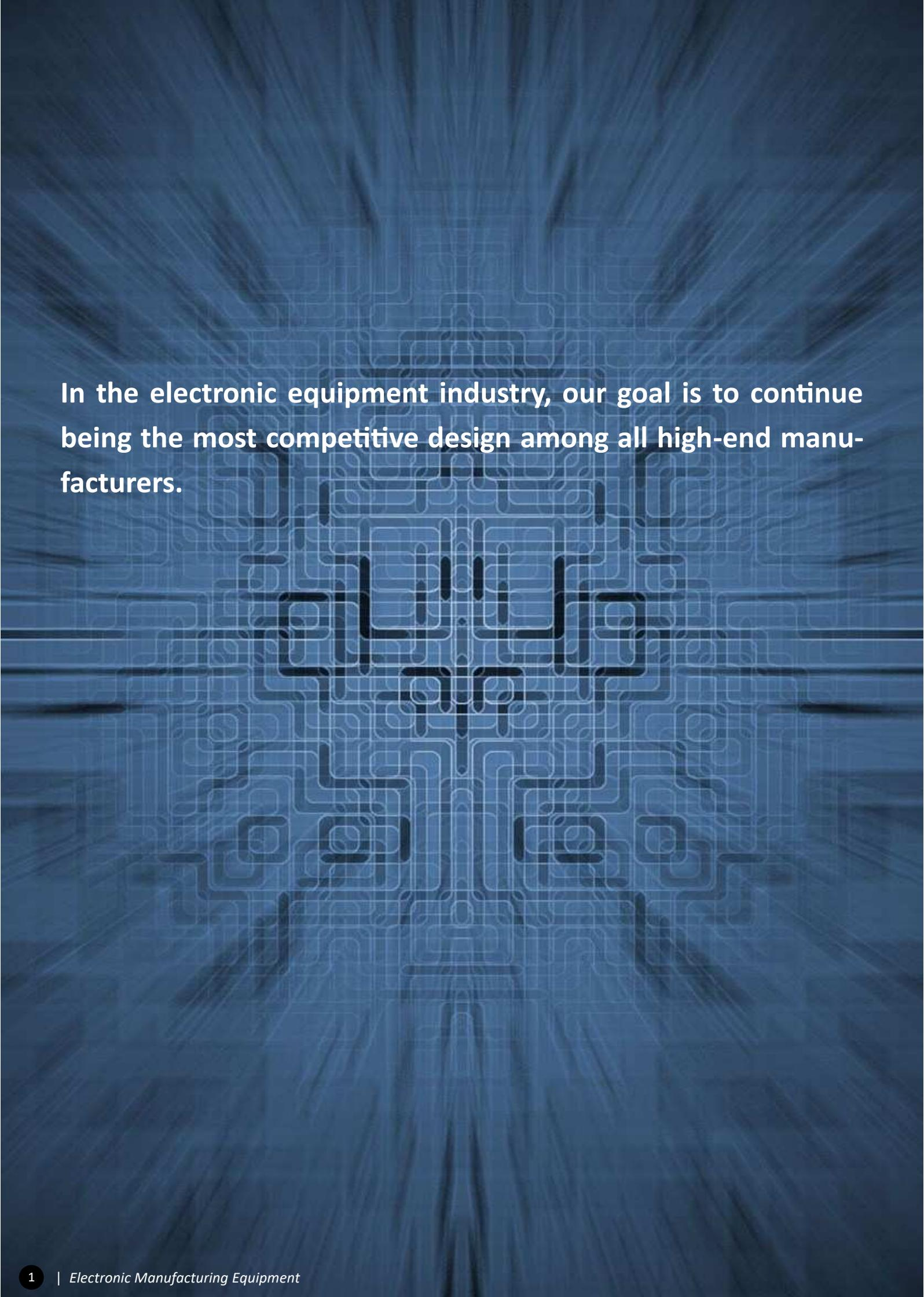

In the electronic equipment industry, our goal is to continue being the most competitive design among all high-end manufacturers.

About Us



e-Flex SMT Microsystems supplies a wide range of the most innovative and reliable types of SMT (Surface Mount Technology) equipment and Electronic devices manufactured in East Asia.

Our goal is to expand day by day into each country and to bring satisfaction to our customers, offering solutions at a cost-effective rate. We are constantly developing and improving our existing models of machinery in order to be up to date to the current levels of sophistication.

Our full line of equipment and accessories is actually fitting every demand of our customer's SMT lines. We bring solutions to every need at a very reasonable cost.

Located in Hong Kong, Asia's World City and home of the Electronics industry in Asia, e-Flex SMT Microsystems services world-wide and has already many distributors in different countries.

We are experts in selecting the best choices of equipment and machinery under the demands of our clients.

With a combination of cost-effective rates and machinery expertise, e-Flex SMT Microsystems is the best choice you might have at the present moment as your SMT supplier.

Process

We always believe that perfect quality should start with good parts, that's why we only choose first-class suppliers

Strictly select spare parts, choose the world class brand parts, to ensure the reliability and durability of the quality of parts

Electric parts

PANASONIC [JAPAN]

SICK [GEMAN]

Q-LIGHT [KOREA]

MEANWELL [TAIWAN(CHINA)]

DELTA [TAIWAN(CHINA)]

YASKAWA [JAPAN]

OMRON [JAPAN]

IDEC [JAPAN]

SHINANOMOTOR [JAPAN]

MOLEX [US]

MITSUBISHI [JAPAN]

SIEMENS[GERMAN]

KEYENCE [JAPAN]

IGUS [GERMAN]

Pneumatic parts

SMC [JAPAN]

AIRTAC [TAIWAN(CHINA)]

Mechanical parts

NSK [JAPAN]

MITSUBOSHI BELT [JAPAN]

TBI MOTION [TAIWAN(CHINA)]

KOYO [JAPAN]

MARTIN [US]

HABASIT [SWISS]

NACHI [JAPAN]

HIWIN [TAIWAN(CHINA)]



Assembly shop

Professional assembly, standardized assembly procedure:

Each device runs at least 24H from the factory and simulates the motion signal

Comply with European safety CE standard to ensure the safety and quality of equipment operation

Strictly according to the factory inspection standards, to ensure that each machine excellent performance

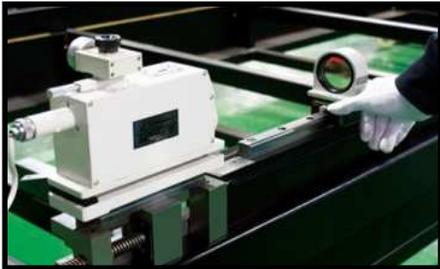

X&Y Guide Rail Testing

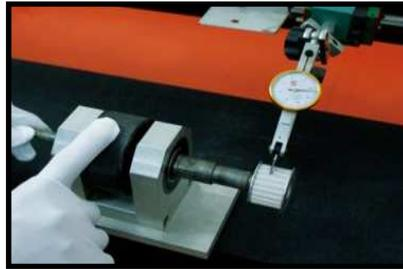

Synchronizing Wheel Testing



Horizontal Testing



■ Inspection Conveyor (Economic Type)

Features

- Modular design, PLC controlled
- Stability enhanced by heavy design
- Worktable included by default
- Smooth and parallel width adjustment (stainless steel screws)
- Different lengths available upon request
- Multi-segment concept available upon request
- Automatic/Manual modes
- Variable speed control
- Inspection button
- SMEMA compatible
- Conveyor height 950 ± 30 mm

Options

- ESD Covers anti-dust
- Touch screen
- High-Clearance on request
- Cooling fans on top/bottom for after-reflow
- Light system for better inspection
- Support for Monitor
- Shelf with ESD component boxes
- Motorized/Automatic width adjustment
- Choice of different belt width and chain transport system
- Mechanical stopper
- Foot pedal pass control
- Narrow footprint
- With bottom cabinet
- Dual Lane



Technical Parameters

Description	This unit is used as a visual inspection station for operators between SMT machines or board handling unit to link the machines.
Belt Type	Antistatic Flat Belt of 3mm width
Conveyor Speed	0.5-20m/min or specify
Power Source	AC 220V, 50/60Hz, 1 phase
Power Consumption	100W MAX

Schematic

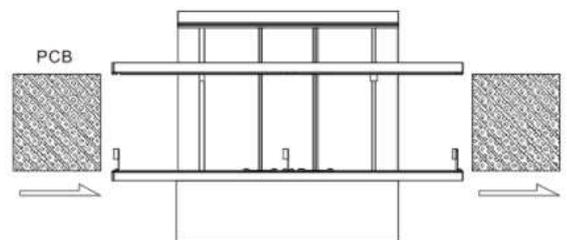

Specification

Length in m	Model	Machine Dimensions(LxWxH) in mm	Effective PCB Size (LxW) in mm	Weight (Kg)
0.5	WH-C050SD3BXL	500x695x980	60x60 - 445x460	87
1.0	WH-C100SD3BXL	1000x755x980	60x60 - 530x460	127
1.5	WH-E150SD3BXL	1500x755x980	60x60 - 695x460	180
2.0	WH-E200SD3BXL	2000x755x980	60x60 - 945x460	220

■ Inspection Conveyor (Hybrid Type)

Features

- Modular design, PLC controlled
- Stability enhanced by heavy design
- High-end rails on top of an economic type structure
- Smooth and parallel width adjustment (stainless steel screws)
- Different lengths available upon request
- Multi-segment concept available upon request
- Automatic/Manual modes
- Variable speed control
- Inspection button
- SMEMA compatible
- Conveyor height 950 ± 30 mm



Options

- ESD Covers anti-dust
- Touch screen
- High-Clearance on request
- Cooling fans on top/bottom for after-reflow
- Light system for better inspection
- Support for Monitor
- Shelf with ESD component boxes
- Motorized/Automatic width adjustment
- Choice of different belt width and chain transport system
- Mechanical stopper
- Foot pedal pass control
- Narrow footprint
- Safety interlocker for the covers
- Dual Lane

Technical Parameters

Description	This unit is used as a visual inspection station for operators between SMT machines or board handling unit to link the machines.
Belt Type	Antistatic Flat Belt of 3mm width
Conveyor Speed	0.5-20m/min or specify
Power Source	AC 220V, 50/60Hz, 1 phase
Power Consumption	100W Max.

Schematic

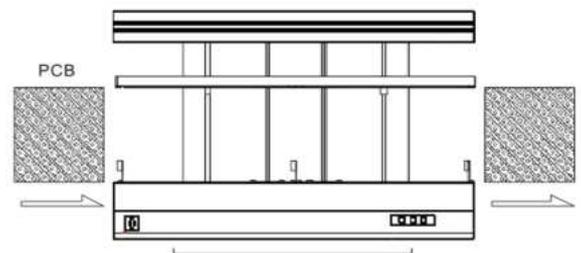

Specification

Units in mm

Length in m	Model	Machine Dimensions(LxWxH) in mm	Effective PCB Size (LxW) in mm	Weight (Kg)
0.5	WH-C050ZD3BXL	500x695x980	60x60 - 445x460	87
1.0	WH-C100ZD3BXL	1000x755x980	60x60 - 530x460	127
1.5	WH-E150ZD3BXL	1500x755x980	60x60 - 695x460	180
2.0	WH-E200ZD3BXL	2000x755x980	60x60 - 945x460	220

Inspection Conveyor (High-End Type)

Features

- Modular design, PLC controlled
- Stability enhanced by heavy design
- Beautiful design with aluminum finishing
- Smooth and parallel width adjustment (stainless steel screws)
- Different lengths available upon request
- Multi-segment concept available upon request
- Automatic/Manual modes
- Variable speed control
- Inspection button
- SMEMA compatible
- Conveyor height $950 \pm 30\text{mm}$

Options

- ESD Covers anti-dust
- Touch screen
- High-Clearance on request
- Cooling fans on top/bottom for after-reflow
- Light system for better inspection
- Support for Monitor
- Shelf with ESD component boxes
- Motorized/Automatic width adjustment
- Choice of different belt width and chain transport system
- Mechanical stopper
- Foot pedal pass control
- Narrow footprint
- Safety interlocker for the covers
- Dual Lane



Technical Parameters

Description	This unit is used as a visual inspection station for operators between SMT machines or board handling unit to link the machines.
Belt Type	Antistatic Flat Belt of 3mm width
Conveyor Speed	0.5-20m/min or specify
Power Source	AC 220V, 50/60Hz, 1 phase
Power Consumption	100W Max.

Schematic

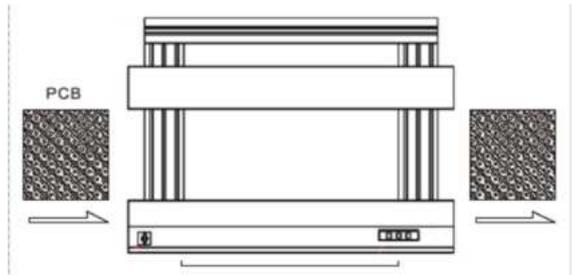

Specification

Length in m	Model	Machine Dimensions(LxWxH) in mm	Effective PCB Size (LxW) in mm	Weight (Kg)
0.5	WH-C050HD3BXL	500x780x980	60x60 - 445x460	87
1.0	WH-C100HD3BXL	1000x849x980	60x60 - 530x460	129
1.5	WH-C150HD3BXL	1500x790x980	60x60 - 695x460	180
2.0	WH-C200HD3BXL	2000x849x980	60x60 - 945x460	240



High-End Workstation

Features

- Modular design, PLC controlled
- Stability enhanced by heavy design
- Narrow front-end
- Smooth and parallel width adjustment (stainless steel screws)
- Different lengths available upon request
- Multi-segment concept available upon request
- Automatic/Manual modes
- Flat-type buttons with LED ring
- ESD wrist strap connection box
- SMEMA compatible
- Conveyor height 950 ± 30 mm
- Wider more robust light supports

Options

- Touch screen
- High-Clearance on request
- Different types of shelving
- Light balancer rails to hang electric screwdrivers
- Strong support for Monitor
- Tool box with perforated panel
- Motorized/Automatic width adjustment
- Choice of different belt width and chain transport system
- Mechanical stopper
- Foot pedal pass control
- Grill-type lights
- Power outlet rail
- Rear Computer tray
- Dual Lane

Technical Parameters

Description	This unit is used as a visual inspection station for operators between SMT machines or board handling unit to link the machines.
Belt Type	Antistatic Flat Belt of 12mm width, or chain
Conveyor Speed	0.5-20m/min or specify
Power Source	AC 220V, 50/60Hz, 1 phase
Power Consumption	100W Max.

Schematic

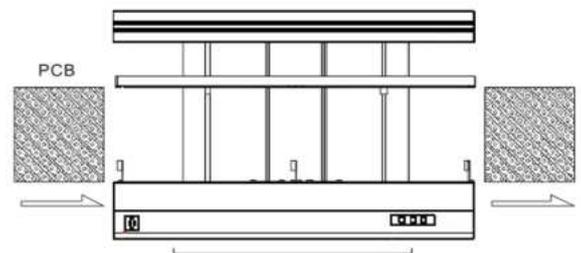

Specification

Length in m	Model	Machine Dimensions(LxWxH) in mm	Effective PCB Size (LxW) in mm	Weight (Kg)
1.0	WH-C100HD12BXL-DW(S)	1000x1005x982	60x60 - 530x460	150
1.5	WH-E150HD12BXL-DW(S)	1500x1005x982	60x60 - 530x460	200

Reject Conveyor

Features

- Modular design, PLC controlled
- Stability enhanced by heavy design
- Beautiful design with aluminum finishings
- Smooth and parallel width adjustment (stainless steel screws)
- Different lengths available upon request
- Touch screen control
- Stacks up to 2 NG boards
- Multi-segment concept available upon request
- Automatic/Manual modes
- Reject, inspect and pass-through modes
- Variable speed control
- SMEMA compatible
- Conveyor height $950 \pm 30\text{mm}$



Options

- High-clearance on request
- Ergonomic design arm rest on the front
- Automatic width adjustment
- Multiple belt width and chain transport system available
- 5 NG boards capacity
- Signal tower for warning when the platform is full

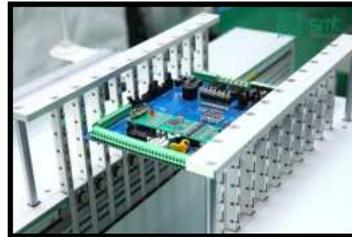

Lifting Platform



Touch Screen Control

Technical Parameters

Description	This unit allows Good and NG board separation in a production line. It can be used when visual inspection of PCB's is required. PCB's will continue to run, thus without interrupting the PCB flow
Belt Type	Antistatic Flat Belt of 3mm width
Conveyor Speed	0.5-20m/min or specify
Power Source	AC 220V, 50/60Hz, 1 phase
Power Consumption	100 Max
Air Pressure & Consume	4-6 bar, 10 l/min Max.

Schematic

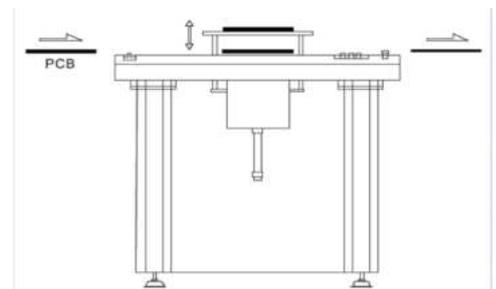

Specification

Length in m	Model	Machine Dimensions(LxWxH) in mm	Effective PCB Size (LxW) in mm	Weight (Kg)
0.5	WH-C050ZD3TXL-R2	500x765x980	60x60 - 445x460	142
1.0	WH-C100HD3TXL-R2	1000x890x980	60x60 - 530x460	200

Flash-Off Conveyor



UV Inspection



Exhaust sensor

Features

- Modular design, PLC controlled
- Smooth and parallel width adjustment (stainless steel screws)
- Covers which protect the boards against dust
- Segments with independent flash-off time (programmable)
- Automatic/Manual modes with inspection button
- Independent variable speed controls for each rail
- SMEMA compatible
- Conveyor height 950 ± 30 mm
- Extractable tray for easy clean-up of coating droplets
- Full control and settings by touch screen
- Exhaust sensor which forces to use air extraction

Options

- UV lights to analyze the coating result over the boards
- Automatic width adjustment
- Safety interlocker for covers
- 3 color signal tower
- Choice of different belt width and chain transport system
- Foot pedal
- Mechanical stopper

Technical Parameters

Description	This unit is used as a visual inspection station for operators controlling the boards right after a conformal coating line.
Belt Type	Antistatic Flat Belt of 12mm width
Conveyor Speed	0.5-20m/min or specify
Power Source	AC 220V, 50/60Hz, 1 phase
Power Consumption	100 W

Schematic

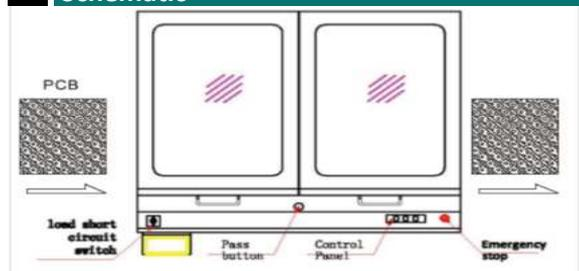

Specification

Units in mm

Length in m	Model	Machine Dimensions(LxWxH) in mm	Effective PCB Size (LxW) in mm	Weight (Kg)
0.5	WH-C50HD12TXL-CALOUVT	500X1013X980	60x60 - 445x460	110
1.0	WH-E100HD12TXL-CALOUVT	1000x990x980	60x60 - 530X460	150

UV Station Conveyor



Features

- Modular design, PLC controlled
- Stability enhanced by heavy design
- Beautiful design with aluminum finishings
- Smooth and parallel width adjustment (stainless steel screws)
- Different lengths available upon request
- Touch screen control
- Top compartment to store tools and coating material.
- Multi-segment concept available upon request
- Automatic/Manual modes
- UV LED inspection modules
- Black coated inner side, for UV inspection effective control
- Exhaust sensor which forces to use air extraction
- Variable speed control
- SMEMA compatible
- Conveyor height 950±30mm

Options

- High-clearance on request
- Ergonomic design arm rest on the front
- Automatic width adjustment
- Multiple belt width and chain transport system available
- Foot pedal
- Mechanical stopper
- Signal tower for warning when product arrives



Tool Area

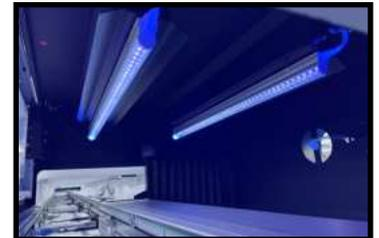

UV Lights and Exhaust connection

Technical Parameters

Description	This unit is used as a visual inspection station for operators controlling the boards right after a conformal coating line, and gives the chance to rework on the product.
Belt Type	Antistatic Flat Belt of 3mm width
Conveyor Speed	0.5-20m/min or specify
Power Source	AC 220V, 50/60Hz, 1 phase
Power Consumption	150 Max
Air Pressure & Consume	4-6 bar, 10 l/min Max.

Schematic

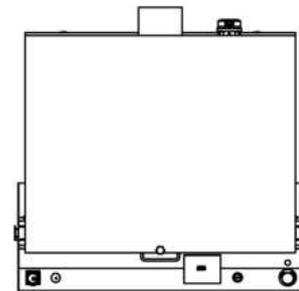

Specification

Length in m	Model	Machine Dimensions(LxWxH) in mm	Effective PCB Size (LxW) in mm	Weight (Kg)
1.0	WH-C100HD3TXL-OUVT(UC)	1000x915x1554	60x60 - 530x460	200



Black Box Station Conveyor



Customized shelving and supports

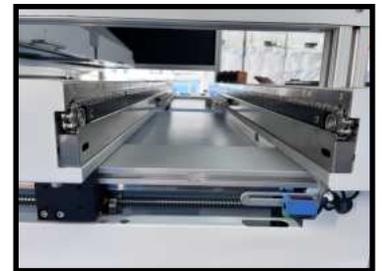

Optional chain

Features

- Modular design, PLC controlled
- Smooth and parallel width adjustment (stainless steel screws)
- Black Box Cover to install customized supports and shelving
- Segments with independent flash-off time (programmable)
- Automatic/Manual modes with inspection button
- Independent variable speed controls for each rail
- SMEMA compatible
- Conveyor height $950 \pm 30\text{mm}$
- Full control and settings by touch screen
- Exhaust sensor which forces to use air extraction

Options

- Automatic width adjustment
- 3 color signal tower
- Choice of different belt width and chain transport system
- Foot pedal
- Mechanical stopper
- Extractable tray for keyboard
- Customized Shelves
- Monitor supports
- UV lights to analyze the coating result over the boards
- Ejector system

Technical Parameters

Description	This unit is used as a visual inspection station for operators controlling the boards right after a special process.
Belt Type	Antistatic Flat Belt of 12mm width
Conveyor Speed	0.5-20m/min or specify
Power Source	AC 220V, 50/60Hz, 1 phase
Power Consumption	150 W

Schematic

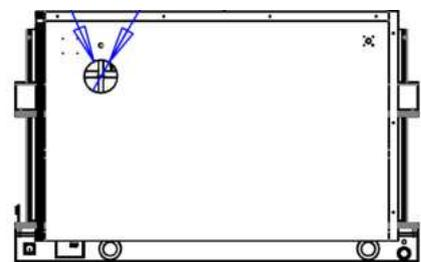

Specification

Units in mm

Length in m	Model	Machine Dimensions(LxWxH) in mm	Effective PCB Size (LxW) in mm	Weight (Kg)
1.0	WH-E100HD12TXL-(UCS)	1000x1253x2409	60x60 - 445x460	150
1.8	WH-E180HD12TXL-(UCS)	1800x1253x2409	60x60 - 530x460	210

Manual Lifting Gate Conveyor

Features

- Lowering & lifting of the gate conveyor is done manually
- Safety sensor installed to enhance safety
- 650mm passage way, or specify
- Variable speed control
- Conveyor height 950 ± 30 mm
- SMEMA compatible

Options

- High-end rail
- ESD Covers anti-dust
- Touch screen
- High-Clearance on request
- Motorized/Automatic width adjustment
- Choice of different belt width and chain transport system



Technical Parameters

Description	This unit is used to allow passage across the line when required.
Belt Type	Antistatic Flat Belt of 3mm width
Conveyor Speed	0.5-20m/min or specify
Power Source	AC 220V, 50/60Hz, 1 phase
Power Consumption	100 Max
Cycle time	Approx. 6 Seconds

Schematic

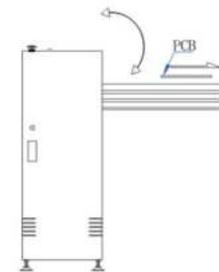

Specification

Size	Model	Machine Dimensions(LxWxH) in mm	Effective PCB Size (LxW) in mm	Weight (Kg)
L	WHM-021SD3BL	1060x830x1310	80x80- 445X330	160
XL	WHM-021SD3BXL	1060x950x1310	80x80 - 530x460	280

Lowering Gate Conveyor

Features

- Lowering & lifting of the gate conveyor is done by push buttons
- Safety barrier sensors installed to enhance safety
- 500mm passage way
- Variable speed control
- Conveyor height 950 ± 30 mm
- SMEMA compatible

Options

- High-end rail
- ESD Covers anti-dust
- Touch screen
- High-Clearance on request
- Motorized/Automatic width adjustment
- Choice of different belt width and chain transport system



Technical Parameters

Description	This unit is used to allow passage across the line when required.
Belt Type	Antistatic Flat Belt of 3mm width
Conveyor Speed	0.5-20m/min or specify
Power Source	AC 220V, 50/60Hz, 1 phase
Power Consumption	100 Max
Air Pressure & Consume	4-6 bar, 48 l/min Max.

Schematic

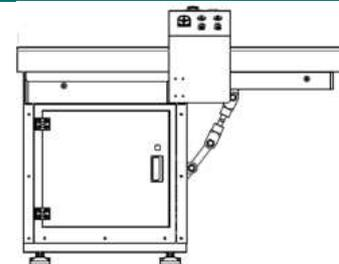

Specification

Units in mm

Size	Model	Machine Dimensions(LxWxH) in mm	Effective PCB Size (LxW) in mm	Weight (Kg)
XL	WHM-022SD3BXL	1300x696x1025	80x80 - 530x460	200

Shuttle Conveyor

Features

- Simple touch screen control panel
- Enclosed design ensures high level of safety
- Swift, smooth and precise operation
- Auto-width adjustment
- Different lengths available upon request
- Different working ways upon request
- SMEMA compatible
- Conveyor height 950 ± 30 mm

Options

- High-Clearance on request
- Choice of different belt width and chain transport system

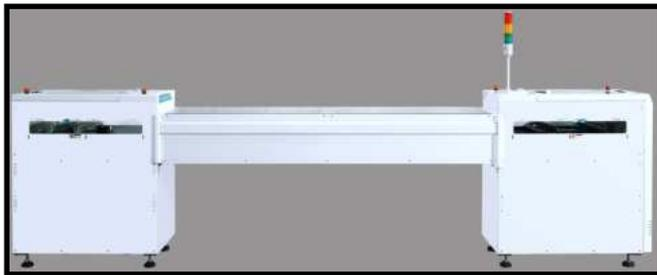

Long Version

Technical Parameters

Description	This unit is used to redirect the PCB's flow into different channels in a production line.
Belt Type	Antistatic Flat Belt of 3mm width
Cycle Time	Depending on traversing distance
Power Source	AC 220V, 50/60Hz, 1 phase
Power Consumption	250 Max

Schematic

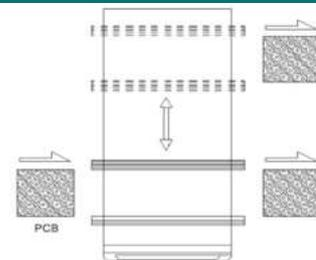

Specification

Size	Model	Machine Dimensions (LxWxH) in mm	Effective PCB Size (LxW) in mm	Weight (Kg)	Traversing distance in mm
M	WHM-22010SD3TM	503x1050x950	80x80 - 330x280	140	500
L	WHM-22013SD3TL	503x1350x950	80x80 - 445x390	200	500
XL	WHM-22013SD3TXL	503x1550x950	80x80 - 530x460	260	500

Telescopic Gate Conveyor



Features

- User friendly soft touch LED membrane control panel
- Swift and smooth retraction/extension of the conveyor
- This machine comes in two versions:
 - Normally open:** The gate is always open, and when a PCB arrives the machine, the gate closes to deliver the PCB to the next machine.
 - Normally closed:** The gate is always closed, and when somebody wants to cross, he can open the gate by pressing a button.
- Safety sensor installed to enhance safety
- 850mm passage way, or specify
- Conveyor height 950 ± 30 mm
- SMEMA compatible

Options

- High-end rail
- High-Clearance on request
- Motorized/Automatic width adjustment
- Choice of different belt width and chain transport system



Open Gate



Internal lifter (NC)

Technical Parameters

Description	This unit is used to allow passage across the line when required.
Belt Type	Antistatic Flat Belt of 3mm width
Cycle Time	Approx. 12 seconds
Power Source	AC 220V, 50/60Hz, 1 phase
Power Consumption	300 Max
Air Pressure & Consume	4-6 bar, 16 l/min Max.

Schematic

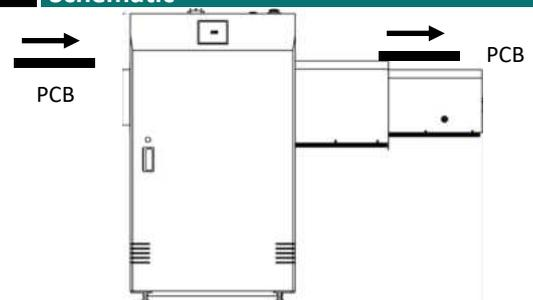

Specification

Units in mm

Size	Model	Machine Dimensions (LxWxH) in mm	Effective PCB Size (LxW) in mm	Weight (Kg)
L	WHM-023SD3BL (Normally Open)	1500x848x1300	80x80 - 445x330	250
XL	WHM-023SD3BXL (Normally Open)	1500x950x1300	80x80 - 530x460	300
L	WHM-027SD3BL (Normally Closed)	1550x850x1300	80x80 - 445x330	250
XL	WHM-027SD3BXL (Normally Closed)	1550x950x1300	80x80 - 530x460	300

Multi-Function Magazine Buffer

Features

- User friendly touch screen control
- Top & bottom pneumatic clamps to secure magazine rack
- Pressure regulated pusher to prevent board damage
- Fast, smooth and precise indexing
- Available modes: Pass-through, Loader, Unloader, NG, LIFO.
- Conveyor height 950 ± 30 mm
- SMEMA compatible

Option

- Additional magazines buffering capacity available upon request
- Panasonic Servomotor for FIFO mode
- Automatic width adjustment
- Cooling fans
- Safety interlockers



Double cylinder



Technical Parameters

Description	This unit is actually used as a combination of loader/unloader/magazine rack buffer.
Capacity	Up: 1 rack; Down: 2 racks
Cycle Time	Approx. 20 seconds
Indexing Pitch	10, 20, 30, 40mm or specify
Power Source	AC 220V, 50/60Hz, 1 phase
Power Consumption	300W Max.
Air Pressure & Consume	4-6 bar, 15 l/min Max.

Schematic

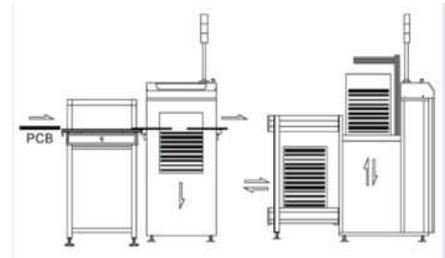

Specification

Size	Model	Machine Dimensions (LxWxH) in mm	Effective PCB Size (LxW) in mm	Rack Size (LxWxH)	Weight (Kg)
M	WHM-101SD3TM-C	1043X1642X1205	80x80 - 330x250	355x320x563	180
L	WHM-101SD3TL-C	1123x1957x1205	80x80 - 445x330	460x400x563	200
LL	WHM-101SD3TLL-C	1435X2182X1205	80x80 - 530x390	535x460x570	220
XL	WHM-101SD3TXL-C	1505X2182X1205	80x80 - 530x460	535x530x570	240

Multi-Function Vertical Buffer



Features

- User friendly touch screen control panel
- FIFO, LIFO and pass-through operating modes selectable
- Fast, smooth and precise indexing (Panasonic Servomotor control)
- Selectable system threshold
- Smooth and parallel width adjustment (lead screw)
- Conveyor height $950 \pm 30\text{mm}$
- SMEMA compatible
- Up to 25 slots for PCB storage

Options

- Side conveyor
- Automatic width adjustment
- Safety interlockers
- Speed control
- Cooling fans



Internal belts



Technical Parameters

Description	This unit is used as a buffer between SMT machines
Cycle Time	Approx. 10 seconds
Max. PCB Capacity	25 pcs maximum (20mm between slots)
Internal belts Type	Antistatic Flat Belt of 3mm width
Indexing Pitch	1 or 2 (20mm/40mm)
Power Source	AC 220V, 50/60Hz, 1 phase
Power Consumption	900W Max.
Air Pressure & Consume	4-6 bar, 15 l/min Max.

Schematic

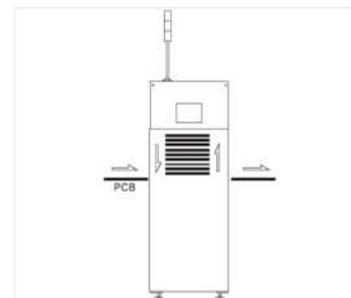

Specification

Size	Model	Machine Dimensions (LxWxH) in mm	Effective PCB Size (LxWxH) in mm	Weight (Kg)
M	WHM-102SD3TM	505x876x1600	80x80- 330x250	380
L	WHM-102SD3TL	505x936x1600	80x80-440x350	400
XL	WHM-102SD3TXL	605x1070x1600	80x80-530x460	420

LIFO Vertical Buffer

Features

- User friendly soft touch LED membrane control panel
- Last In First Out (LIFO) and pass-through modes selectable
- Durable rollers as conveying transport (no belts)
- Smooth and parallel width adjustment (lead screw)
- Conveyor height 950 ± 30mm
- SMEMA compatible

Options

- Side conveyor
- Automatic width adjustment
- Safety interlockers
- Cooling fans
- Exhaust sensor



Roller and metal support



Technical Parameters

Description	This unit is used as a buffer between SMT machines
Cycle Time	Approx. 10 seconds
Max. PCB Capacity	20 pcs maximum (25mm between slots)
Max. PCB load	1.5Kg/PCB
Indexing Pitch	1 or 2 (25mm/50mm)
Power Source	AC 220V, 50/60Hz, 1 phase
Power Consumption	900W Max.
Air Pressure & Consume	4-6 bar, 15 l/min Max.

Schematic

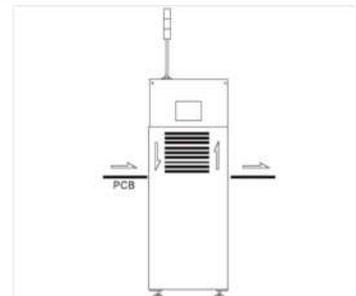

Specification

Size	Model	Machine Dimensions (LxWxH) in mm	Effective PCB Size (LxW) in mm	Weight (Kg)
L	WHM-103SD0BL-C	505x936x1600	80x80 - 445x330	220
XL	WHM-103SD0BXL-C	605x1070x1600	80x80 - 530x460	240

■ NG/OK Vertical Buffer



Features

- User friendly touch screen control panel
- Accumulates NG boards while OK boards continue
- NG boards can be taken out manually and reinserted after
- Fast, smooth and precise indexing (servo motor driven)
- Smooth and parallel width adjustment (lead screw)
- Conveyor height 950 ± 30 mm
- SMEMA compatible

Options

- Automatic width adjustment
- Safety interlockers
- Chain system instead of belt

Technical Parameters

Description	This unit is used as a buffer to store NG and OK boards after an inspection machine (AOI/SPI), and to pass the OK boards to the next process. The NG boards will go to the upper conveyor for visual inspection.
Internal belts Type	Antistatic Flat Belt of 3mm width
Max. PCB Capacity	15 pcs maximum
Max. PCB load	2Kg/PCB
Indexing Pitch	1 or 2
Power Source	AC 220V, 50/60Hz, 1 phase
Power Consumption	900W Max.
Air Pressure & Consume	4-6 bar, 15 l/min Max.

Schematic

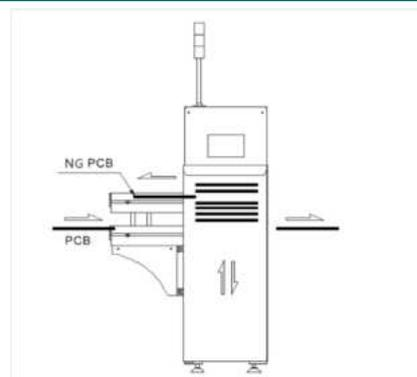

Specification

Size	Model	Machine Dimensions (LxWxH) in mm	Effective PCB Size (LxW) in mm	Weight (Kg)
M	WHM-106SD3TM	1107x876x1600	80x80-330x250	380
L	WHM-106SD3TL	1107x936x1600	80x80-440x350	400
XL	WHM-106SD3TXL	1207x1070x1600	80x80-530x460	420

Multi-Function Double Buffer

Features

- User friendly touch screen control panel
- FIFO, LIFO and pass-through operating modes selectable
- Fast, smooth and precise indexing (Panasonic Servomotor control)
- Selectable system threshold
- Smooth and parallel width adjustment (lead screw)
- Conveyor height $950 \pm 30\text{mm}$
- SMEMA compatible
- Up to 40 slots for PCB storage

Options

- Automatic width adjustment
- Safety interlockers
- Speed control
- Cooling fans
- Dual Lane

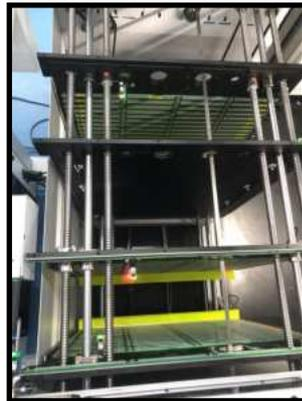

Double cage



Technical Parameters

Description	This unit is used as a buffer between SMT machines
Cycle Time	Approx. 10 seconds
Max. PCB Capacity	40 pcs maximum (25mm between slots)
Max. PCB load	1.5Kg/PCB
Indexing Pitch	1 or 2 (25mm/50mm)
Power Source	AC 220V, 50/60Hz, 1 phase
Power Consumption	900W Max.
Air Pressure & Consume	4-6 bar, 15 l/min Max.

Schematic

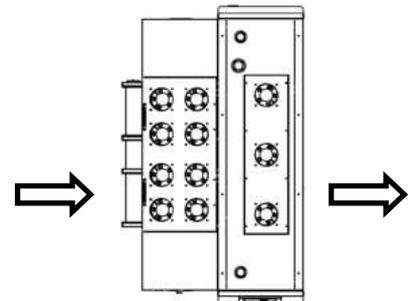

Specification

Size	Model	Machine Dimensions (LxWxH) in mm	Effective PCB Size (LxW) in mm	Weight (Kg)
M	WHM-112SD3TM	901x1492x1326	80x80 - 330x250	360
XL	WHM-112SD3TXL	1254x1812x1326	80x80 - 530x460	440

■ NG/OK Double Buffer



Features

- User friendly touch screen control panel
- Accumulates NG boards while OK boards continue
- NG boards can be taken out manually and reinserted after
- Fast, smooth and precise indexing (servo motor driven)
- Smooth and parallel width adjustment (lead screw)
- Conveyor height 950 ± 30 mm
- SMEMA compatible

Options

- Automatic width adjustment
- Safety interlockers
- Chain system instead of belt
- Dual lane



Double conveyor platform

Technical Parameters

Description	This unit is used as a buffer to store NG and OK boards after an inspection machine (AOI/SPI), and to pass the OK boards to the next process. The NG boards will go to the upper conveyor for visual inspection.
Internal belts Type	Antistatic Flat Belt of 3mm width
Max. PCB Capacity	40 pcs maximum (25mm between slots)
Max. PCB load	1.5 Kg/PCB
Indexing Pitch	1 or 2 (25mm/50mm)
Power Source	AC 220V, 50/60Hz, 1 phase
Power Consumption	900W Max.
Air Pressure & Consume	4-6 bar, 15 l/min Max.

Schematic

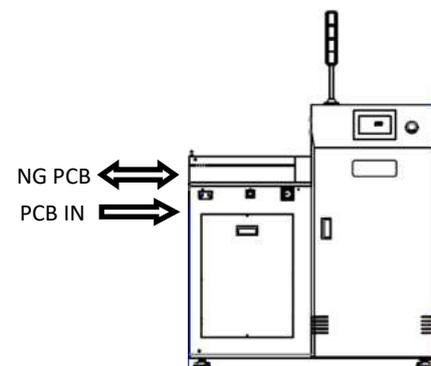

Specification

Size	Model	Machine Dimensions (LxWxH) in mm	Effective PCB Size (LxW) in mm	Weight (Kg)
M	WHM-115SD3TM	1254x1572x1600	80x80-330x250	380

Heavy-Duty Buffer

Features

- User friendly touch screen control panel
- FIFO, LIFO and pass-through operating modes selectable
- Fast, smooth and precise indexing (Freq. inverter controller)
- Selectable system threshold
- Smooth and parallel width adjustment (lead screw)
- Conveyor height 950 ± 30 mm
- SMEMA compatible
- Support heavy pallets
- High-clearance for boards with tall components

Options

- Side conveyor
- UV light
- Automatic width adjustment
- Safety interlockers
- Chain system instead of belt
- Flash-off timer and exhaust sensor



8 slots for higher clearance

Technical Parameters

Description	This unit is used as a buffer in between machines, usually for conformal coating lines
Cycle Time	Approx. 10 seconds
Max. PCB Capacity	8 pcs maximum(60mm between slots)
Internal belts Type	Antistatic Flat Belt of 8~12mm width
Indexing Pitch	10, 20mm or specify
Power Source	AC 220V, 50/60Hz, 1 phase
Power Consumption	900W Max.
Air Pressure & Consume	4-6 bar, 15 l/min Max.

Schematic

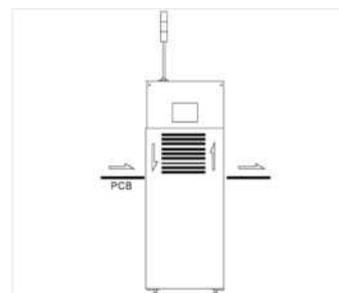

Specification

Size	Model	Machine Dimensions (LxWxH) in mm	Effective PCB Size (LxW) in mm	Rack Size (LxWxH)	Weight (Kg)
L	WHM-108SD3TL-C	1010x870x1205	80x80 - 445x330	460x400x563	200
XL	WHM-108SD3TXL-C	1110x930x1205	80x80 - 530x460	535x530x570	240



Curing Buffer

Features

- User friendly touch screen control panel
- FIFO, LIFO and pass-through operating modes selectable
- Fast, smooth and precise indexing (Freq. inverter controller)
- Selectable system threshold
- Smooth and parallel width adjustment (lead screw)
- Conveyor height 950 ± 30 mm
- SMEMA compatible
- Industrial heater to generate a curing chamber inside of the buffer main body
- Temperature control and monitor
- Programmable curing time
- Exhaust sensor

Options

- UV light
- Automatic width adjustment
- Safety interlockers
- Wider belts or chain system

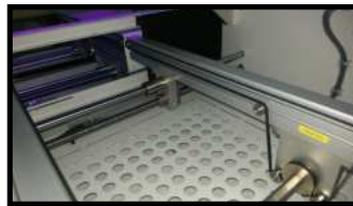

Bottom holes to distribute the heat inside the conveyor



Industrial heater to generate a curing temperature inside of the machine

Technical Parameters

Description	This unit is used as a curing chamber in between machines, and will keep the board at a curing tempera-
Cycle Time	Approx. 10 seconds
Max. PCB Capacity	25 pcs maximum
Internal belts Type	Antistatic Flat Belt of 3 mm width
Indexing Pitch	10, 20mm or specify
Power Source	AC 220V, 50/60Hz, 1 phase
Power Consumption	900W Max.
Air Pressure & Consume	4-6 bar, 15 l/min Max.

Schematic

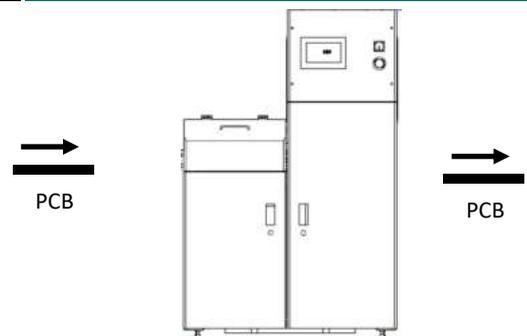

Specification

Size	Model	Machine Dimensions (LxWxH) in mm	Effective PCB Size (LxW) in mm	Weight (Kg)
L	WHM-102SD3TL-JCOH	1256x887x1600	80x80-440X350	400
XL	WHM-102SD3TXL-JCOJH	1356x947x1600	80x80-530X460	420

Turn Conveyor

Features

- User friendly soft touch LED membrane control panel
- Enclosed design with built-in torque limiter to ensure a high level of safety
- Smooth and precise rotation
- Conveyor height 950 ± 30mm
- SMEMA compatible

Options

- Motorized width adjustment
- Automatic width adjustment
- Different belt width or chain system
- Safety interlockers
- Touch screen



Technical Parameters

Description	This unit is used to redirect the PCB flow in a production line (90°, 180°, 270°).
Belt Type	Antistatic Flat Belt of 3mm width
Cycle Time	Approx. 12 seconds
Power Source	AC 220V, 50/60Hz, 1 phase
Power Consumption	300 Max

Schematic

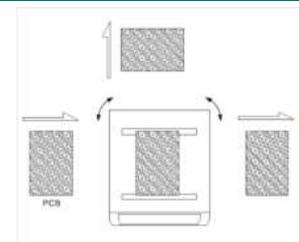

Specification

Units in mm

Size	Model	Machine Dimensions(LxWxH) in mm	Effective PCB Size (LxH) in mm	Weight (Kg)
M	WHM-210SD3BM	500x500x1200	80x80 - 330x250	350
L	WHM-210SD3BL	653x718x1200	80x80 - 445x330	380
LL	WHM-210SD3BL	756x756x1200	80x80 - 530x390	395
XL	WHM-210SD3BXL	856x920x1205	80x80 - 530x460	410

PCB Inverter



Features

- User friendly soft touch screen
- Automatic width adjustment
- Enclosed design with built-in torque limiter to ensure a high level of safety
- Smooth and precise inverting motion
- Conveyor height 950 ± 30 mm
- SMEMA compatible.
- Four different inversion modes available on demand: pass-through, normal inversion, double downstream inversion(2 types).

Options

- Safety interlockers
- Different belt width or chain system
- Coating lines model available, with stronger modular piston and rails.
- Sliding doors/shutters



Internal belts



Heavy Duty Inverter Available on Demand

Technical Parameters

Description	This unit is used to invert PCB's (180 °) for double side processes.
Belt Type	Antistatic Flat Belt of 3mm width
Cycle Time	Approx. 12 seconds
Power Source	AC 220V, 50/60Hz, 1 phase
Power Consumption	300 Max
Air Pressure & Consume	4-6 bar, 1.1 l/min Max.

Schematic

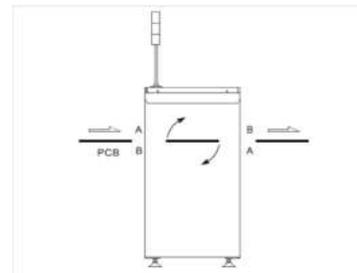

Specification

Units in mm

Size	Model	Machine Dimensions(LxWxH) in mm	Effective PCB Size (LxH) in mm	Weight (Kg)
M	WHM-200SD3TM-A	504x869x1250	80x80 - 330x250	155
L	WHM-200SD3TL-A	554x929x1250	80x80 - 480x390	165
XL	WHM-200SD3TXL-A	655x1050x1250	80x80 - 530x460	175

Transversal Inverter

Features

- User friendly touchscreen control
- Enclosed design with auto-shuttle platform
- Smooth and precise translation and inverting motion
- Conveyor height 950 ± 30 mm
- SMEMA compatible
- Automatic width adjustment

Options

- Different belt width or chain system
- Safety interlockers
- Sliding doors/shutters
- Dual Lane

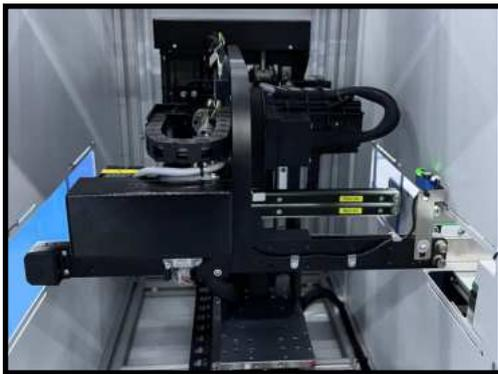

Technical Parameters

Description	This unit is used to invert the board in a transversal way (change the board side, while keeping the front of the board in the front).
Belt Type	Antistatic Flat Belt of 3mm width
Cycle Time	Approx. 12–15 seconds
Power Source	AC 220V, 50/60Hz, 1 phase
Power Consumption	300 Max

Schematic

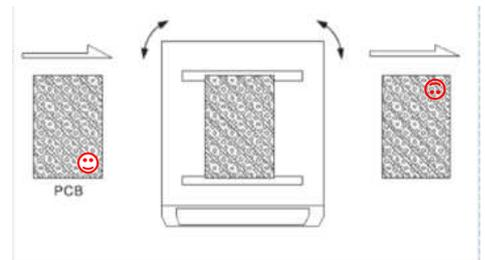

Specification

Units in mm

Size	Model	Machine Dimensions (LxWxH) in mm	Effective PCB Size (LxH) in mm	Weight (Kg)
M	WHM-202SD3TM-A	406x1199x1330	80x80 - 330x250	150
L	WHM-202SD3TL-A	506x1299x1330	80x80 - 445x330	180

Loader/Destacker Combo

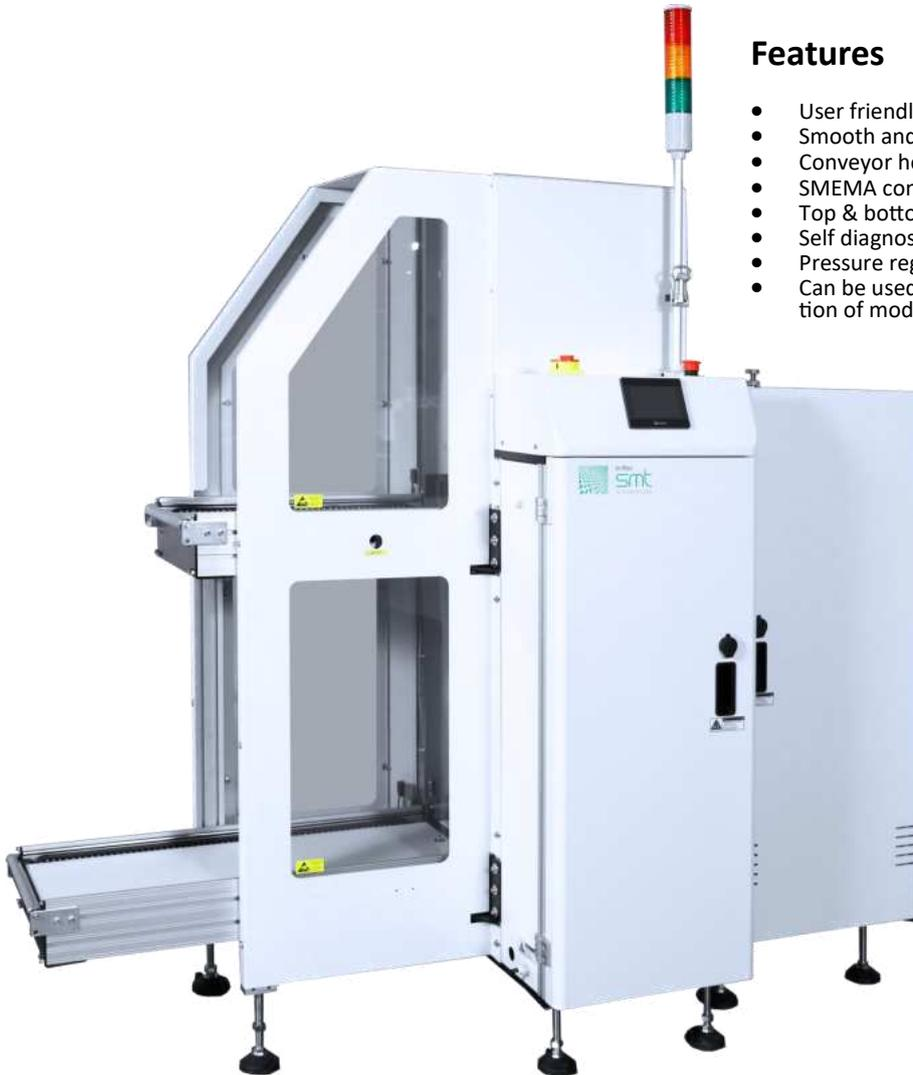

Features

- User friendly soft touch screen
- Smooth and parallel width adjustment by leadscrew
- Conveyor height 950 ± 30mm
- SMEMA compatible.
- Top & bottom pneumatic clamps to secure magazine rack
- Self diagnostic Error code display
- Pressure regulated pusher to prevent board damage
- Can be used as a Loader or as a Destacker, by simple selection of mode.

Options

- Touch screen control
- Motorized/Automatic width adjustment
- Safety interlockers
- Universal type (Multiple magazine sizes)

Technical Parameters

Description	This unit combines the functions of a magazine loader and a destacker.
Belt Type	Antistatic Flat Belt of 3mm width
Magazine Change Time	Approx. 30 seconds
Power Source	AC 220V, 50/60Hz, 1 phase
Power Consumption	300 Max
Air Pressure & Consume	4-6 bar, 1.1 l/min Max.

Schematic

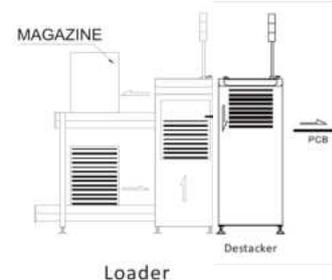

Specification

Units in mm

Size	Model	Rack size (LxWxH) in mm	Machine Dimensions(LxWxH) in mm	Effective PCB Size (LxH) in mm	Weight (Kg)
M	WHM-361SD3TM-C	355x320x563	1850x1035x1905	80x80 - 330x250	330
L	WHM-361SD3TL-C	460X400X563	2297x1035x1905	80x80 - 445X330	370
LL	WHM-361SD3TLL-C	535X460X570	2456x1035x1905	80x80 - 530x390	480
XL	WHM-361SD3TXL-C	535x530x570	2456x1035x1905	80x80 - 530x460	520
XXL	WHM-361SD3TXXL-C	630x530x570	2561x1035x1905	80x80 - 600x460	570

Vacuum Bare Board Loader

Features

- User friendly touch screen control
- Enclosed design to ensure a high level of safety
- Adjustable vacuum stubs positions with magnets to provide a better way to hold the PCB's
- Conveyor height 950 ± 30 mm
- SMEMA compatible
- Pass-through function

Options

- Automatic width adjustment
- Mechanical Stopper
- Different belt width and chain system
- Safety interlocker
- Speed control



Vacuum stubs



Magnetically placed stubs



Technical Parameters

Description	Used for loading bare board PCB's into the line when it's not possible to use a destacker
Max. PCB Capacity	150 mm space for boards
PCB Time Feed	Approx. 10 seconds
Power Source	AC 220V, 50/60Hz, 1 phase
Power Consumption	300 Max
Air Pressure & Consume	4-6 bar, 30 l/min Max.

Schematic

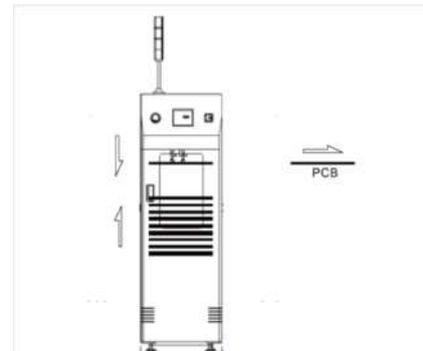

Size	Model	Machine Dimension (LxWxH) in mm	Effective PCB Size (LxW) in mm	Weight (Kg)
L	WHM-310SD3TL	505x940x1170	80x80 - 445x330	180
XL	WHM-310SD3TXL	605x1000x1170	80x80 - 530x460	200

Destacker/Push-up Stacker



Features

- User friendly soft touch LED membrane control panel
- Smooth and parallel width adjustment by leadscrew
- Small machine footprint
- Conveyor height 950 ± 30mm
- SMEMA compatible
- Pass-through function

Options

- Automatic width adjustment
- Motorized width adjustment
- Touch screen
- Safety interlocker



Close-up views

Technical Parameters

Description	These units are for loading or restacking bare board PCB's in/off the line
Belt Type	Antistatic Flat Belt of 3mm width
Max. PCB Capacity	Up to 7 Kg at most
Power Source	AC 220V, 50/60Hz, 1 phase
Power Consumption	300 Max
Air Pressure & Consume	4-6 bar, 30 l/min Max.

Schematic

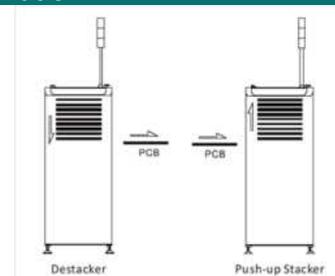

Specification

Units in mm

Machine Type	Size	Model	Machine Dimensions(LxWxH) in mm	Effective PCB Size (LxW) in mm	Weight (Kg)
Destacker	L	WHM-283SD3BL	503x889x1200	80x80 - 400x460	180
	XL	WHM-283SD3BXL	600x1040x1200	80x80 - 530x460	249
Push-up Stacker	L	WHM-281SD3BL	503x889x1200	80x80 - 400x460	180
	XL	WHM-281SD3BXL	600x1040x1200	80x80 - 530x460	249

Vacuum Loader for LED Lights

Features

- User friendly touch screen control
- Enclosed design to ensure a high level of safety
- Adjustable vacuum stubs positions with magnets
- 3 or 8 nozzles type available to select depending on the PCB surface
- Conveyor height 950 ± 30 mm
- SMEMA compatible

Options

- Automatic width adjustment
- Mechanical Stopper
- Different belt width and chain system
- Safety interlocker
- Speed control

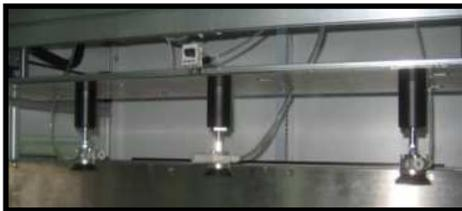

3 big nozzle version



8 small nozzle version

Technical Parameters Schematic

Description	Used for loading long LED bare board PCB's into the line
Max. PCB Capacity	250 mm space for boards
PCB Time Feed	Approx. 10 seconds
Power Source	AC 220V, 50/60Hz, 1 phase
Power Consumption	300 Max
Air Pressure & Consume	4-6 bar, 30 l/min Max.

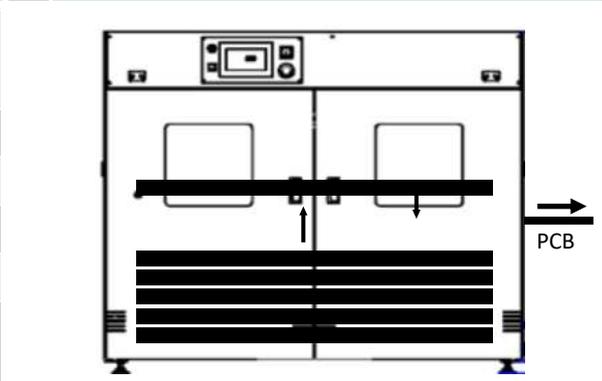

Specification Units in mm

Size	Model	Machine Dimensions (LxWxH)	Effective PCB Size (LxW) in mm	Weight (Kg)
L	WHM-311SD3TL	1500X1028X1519	80x80 - 1200X300	420
XL	WHM-315SD3TXL	1700x1364x1519	80x80 - 1500x300	500

■ Unloader for LED Lights



Features

- User friendly soft touch LED membrane control panel
- Self diagnostic Error code display
- Especial extra length to accommodate long PCBs
- Single inlet/outlet for Triple magazines
- Pressure regulated pusher to prevent board damage
- Conveyor height 950 ± 30 mm
- SMEMA compatible

Options

- Automatic width adjustment
- Mechanical Stopper
- Touch Screen
- Different belt width and chain system
- Safety interlocker
- Speed control

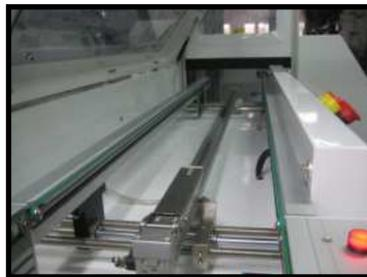

Long entrance conveyor



Makes Use of Triple magazines

Technical Parameters

Description	These units are used for unloading LED bear board off the line when it's not possible to use a normal unloader
Max. PCB Capacity	250 mm space for boards
PCB Time Feed	Approx. 10 seconds
Power Source	AC 220V, 50/60Hz, 1 phase
Power Consumption	300 Max
Air Pressure & Consume	4-6 bar, 30 l/min Max.

Schematic

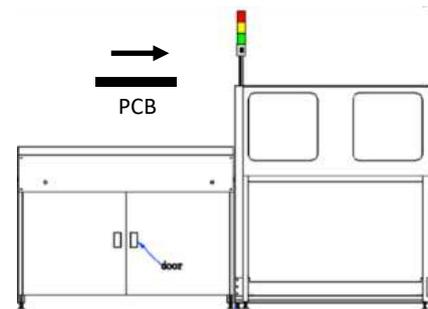

Specification

Units in mm

Size	Model	Machine Dimensions (LxWxH) in mm	Rack size (LxWxH) in mm	Effective PCB Size (LxW) in mm	Weight (Kg)
M	WHM-304SD3BM	2810x1424x1716	800x320x563	80x80 - 800x250	450
L	WHM-304SD3BL	3450x1600x1716	1200x380x563	80x80 - 1200x300	500

Multi Magazine Loader/



LOADER



UNLOADER

Features

- User friendly soft touch LED membrane control panel
- Lifter servomotor controlled
- Top & bottom pneumatic clamps to secure magazine rack
- Self diagnostic Error code display
- Pressure regulated pusher to prevent board damage
- Conveyor height 950 ± 30mm
- SMEMA compatible

Options

- Touch screen control
- Motorized/Automatic width adjustment
- Different belt width and chain system
- Safety interlockers
- Universal type (Multiple magazine sizes)
- Panasonic servomotor
- Side doors for enclosing the magazine inlet/outlet
- Exhaust sensor / flash-off function

Technical Parameters

Description	These units are used for loading and unloading PCBs on/off the line
Capacity	Up: 1 rack; Down: 2 racks
Magazine Change Time	Approx. 30 seconds
Power Source	AC 220V, 50/60Hz, 1 phase
Power Consumption	300 Max
Air Pressure & Consume	4-6 bar, 10 l/min Max.

Schematic

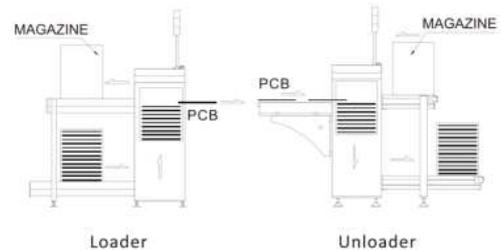

Specification

Machine Type	Size	Model	Rack Size(LxWxH)	Machine Dimensions (LxWxH)	Effective PCB Size	Weight (Kg)
LOADER	M	WHM-300SD0BM-C	355x320x563	1365x769x1795	80x80 - 330x250	270
	L	WHM-300SD0BL-C	460x400x563	1829x848x1795	80x80 - 445x330	300
	LL	WHM-300SD0BLL-C	535x460x570	1904x905x1795	80x80 - 530x390	400
	XL	WHM-300SD0BXL-C	535x530x570	1904x975x1795	80x80 - 530x460	410
	XXL	WHM-300SD0BXXL-C	630x530x570	2200x975x1795	80x80 - 600x460	450
UNLOADER	M	WHM-301SD3BM-C	355x320x563	1898x769x1795	80x80 - 330x250	325
	L	WHM-301SD3BL-C	460x400x563	2454x846x1795	80x80 - 445x330	355
	LL	WHM-301SD3BLL-C	535x460x570	2604x898x1795	80x80 - 530x390	460
	XL	WHM-301SD3BXL-C	535x530x570	2632x973x1795	80x80 - 530x460	470
	XXL	WHM-301SD3BXXL-C	630x530x570	3032x975x1795	80x80 - 600x430	520

Mini Magazine Loader/Unloader



MINI LOADER



MINI UNLOADER

Features

- Especially for factories with limitations of space
- User friendly soft touch LED membrane control panel
- Lifter servomotor controlled
- Top & bottom pneumatic clamps to secure magazine rack
- Self diagnostic Error code display
- Pressure regulated pusher to prevent board damage
- Conveyor height 950 ± 30 mm
- SMEMA compatible

Options

- Touch screen control
- Motorized/Automatic width adjustment
- Safety interlockers
- Different belt width and chain system
- Universal type (Multiple magazine sizes)
- Panasonic Servomotor
- Side doors for enclosing the magazine inlet/outlet
- Exhaust sensor / flash-off function

Technical Parameters

Description	These units are used for loading and unloading PCBs on/off the line
Capacity	Up: 1 rack; Down: 1 rack
Magazine Change Time	Approx. 30 seconds
Power Source	AC 220V, 50/60Hz, 1 phase
Power Consumption	300 Max
Air Pressure & Consume	4-6 bar, 10 l/min Max.

Schematic

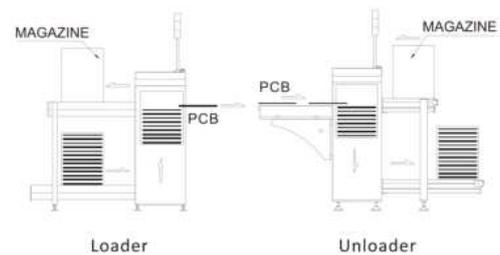

Specification

Machine Type	Size	Model	Rack Size(LxWxH)	Machine Dimensions (LxWxH)	Effective PCB Size	Weight (Kg)
LOADER	M	WHM-320SD0BM-C	355x320x563	1100x766x1670	80x80 - 330x250	150
	L	WHM-320SD0BL-C	460x400x563	1480x850x1670	80x80 - 445x330	190
	LL	WHM-320SD0BLL-C	535x460x570	1646x905x1670	80x80 - 530x390	230
	XL	WHM-320SD0BXL-C	535x530x570	1654x973x1670	80x80 - 530x460	270
	XXL	WHM-320SD0BXXL-C	630x530x570	1754x973x1670	80x80 - 600x460	320
UNLOADER	M	WHM-321SD3BM-C	355x320x563	1618x765x1670	80x80 - 330x250	185
	L	WHM-321SD3BL-C	460x400x563	1760x850x1670	80x80 - 445x330	230
	LL	WHM-321SD3BLL-C	535x460x570	1834x1033x1670	80x80 - 530x390	275
	XL	WHM-321SD3BXL-C	535x530x570	2009x1103x1670	80x80 - 530x460	320
	XXL	WHM-321SD3BXXL-C	630x530x570	2209x 1103x1670	80x80 - 600x460	350

Single Magazine Loader

Features

- User friendly control panel
- Lifter servomotor controlled
- Top & bottom pneumatic clamps to secure magazine rack
- Pressure regulated pusher to prevent board damage
- Foldable pusher box to let operator pass through the line
- Conveyor height 950 ± 30mm
- SMEMA compatible

Options

- Touch screen control
- Motorized/Automatic width adjustment
- Safety interlockers
- Different belt width and chain system
- Universal type (Multiple magazine sizes)
- Panasonic servomotor



Status when the pusher box is folded

Technical Parameters

Description	These units are used for loading PCBs in to the line when there is space limitation
Capacity	1 Single Magazine
Magazine Change Time	Approx. 30 seconds
Indexing Pitch	10, 20, 30, 40, 50, 60, 70, 80, 90, 100 mm
Power Source	AC 220V, 50/60Hz, 1 phase
Power Consumption	300W Max.
Air Pressure & Consume	4-6 bar, 10 l/min Max.

Schematic

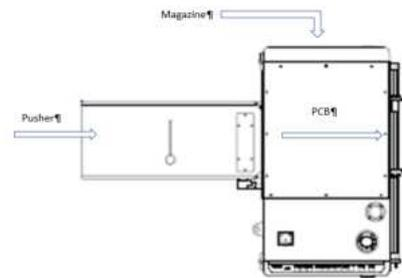

Specification

Size	Model	Machine Dimensions (LxWxH) in mm	Effective PCB Size (LxW) in mm	Rack Size (LxWxH) in mm	Weight (Kg)
M	WHM-314SD0BM-C	794*816*1688(OPEN) 1140*816*1688(CLOSED)	80x80 - 330x250	355x320x563	320
L	WHM-314SD0BLC	900*896*1688(OPEN) 1245*896*1688(CLOSED)	80x80 - 445X330	460X400X563	340
LL	WHM-314SD0BLLC	975*956*1688(OPEN) 1315*956*1688(CLOSED)	80x80 - 530X390	535X460X570	360
XL	WHM-314SD0XL-C	975*1026*1688(OPEN) 1530*1120*1688(CLOSED)	80x80 - 530x460	535x530x570	380

Single Magazine Unloader



Features

- User friendly soft touch LED membrane control panel
- Especially for factories with limitations of space
- Lifter servomotor controlled
- Top & bottom pneumatic clamps to secure magazine rack
- Self diagnostic Error code display
- Pressure regulated pusher to prevent board damage
- Rear door to load/unload a magazine inside the machine
- Conveyor height 950 ± 30 mm
- SMEMA compatible

Options

- Touch screen control
- Motorized/Automatic width adjustment
- Safety interlockers
- Different belt width and chain system
- Universal type (Multiple magazine sizes)
- Panasonic servomotor
- Exhaust sensor / flash-off



Rear Door

Technical Parameters

Description	These units are used for unloading PCBs out of the line when there is space limitation
Capacity	1 Single Magazine
Magazine Change Time	Approx. 30 seconds
Indexing Pitch	10, 20, 30, 40, 50, 60, 70, 80, 90, 100 mm
Power Source	AC 220V, 50/60Hz, 1 phase
Power Consumption	300W Max.
Air Pressure & Consume	4-6 bar, 10 l/min Max.

Schematic

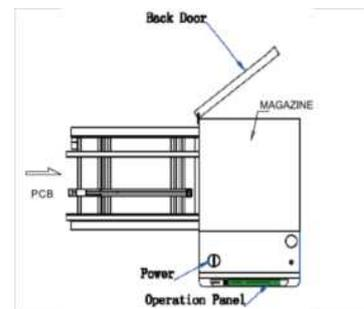

Specification

Units in mm

Size	Model	Machine Dimensions (LxWxH) in mm	Effective PCB Size (LxW) in mm	Rack Size (LxWxH) in mm	Weight (Kg)
M	WHM-302SD3BM-C	1032x819x1682	80x80 - 330x250	355x320x563	400
L	WHM-302SD3BL-C	1186x900x1682	80x80 - 445x330	460x400x563	420
LL	WHM-302D3BLL-C	1413x951x1682	80x80 - 530x390	535x460x570	440
XL	WHM-302SD3BXL-C	1434x1028x1682	80x80 - 530x460	535x530x570	460

90 Degrees Unloader

Features

- User friendly control panel
- Lifter servomotor controlled
- Top & bottom pneumatic clamps to secure magazine rack
- Self diagnostic Error code display
- Pressure regulated pusher to prevent board damage
- Front or Rear unloading to reduce machine length
- Conveyor height 950 ± 30 mm
- SMEMA compatible

Options

- Touch screen control
- Motorized/Automatic width adjustment
- Safety interlockers
- Different belt width and chain system
- Universal type (Multiple magazine sizes)



Rear magazine ramps

Technical Parameters

Description	These units are used for unloading PCBs out of the line through the front or rear side
Capacity	Up: 1 rack; Down: 1 rack
Magazine Change Time	Approx. 30 seconds
Indexing Pitch	10, 20, 30, 40, 50, 60, 70, 80, 90, 100 mm
Power Source	AC 220V, 50/60Hz, 1 phase
Power Consumption	300W Max.
Air Pressure & Consume	4-6 bar, 10 l/min Max.

Schematic

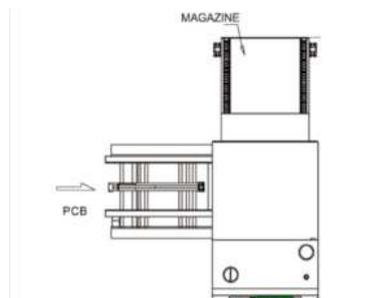

Specification

Specification		Units in mm			
Size	Model	Machine Dimensions (LxWxH) in mm	Effective PCB Size (LxW) in mm	Rack Size (LxWxH) in mm	Weight (Kg)
M	WHM-303SD3BM-C	1036x1621x1682	80x80 - 330x250	355x320x563	400
L	WHM-303SD3BL-C	1240x1896x1682	80x80 - 445x330	460x400x563	420
LL	WHM-303SD3BLL-C	1300x1969x1682	80x80 - 530x390	535x460x570	440
XL	WHM-303SD3BXL-C	1410x2069x1682	80x80 - 530x460	535x530x570	460

Curing Unloader



Features

- User friendly soft touch LED membrane control panel
- Especially for factories with limitations of space
- Entrance conveyor with chain system for transport
- Fully covered configuration to keep heating temperatures
- Top & bottom pneumatic clamps to secure magazine rack
- Pressure regulated pusher to prevent board damage
- Heaters for curing the PCBs
- Thermocouples and timers to ensure the PCBs stay in the curing buffer long enough with the right temperature
- Door with locker on the exit to keep the temperature
- Extra exit magazine ramp to cool the magazine down after curing
- Conveyor height 950 ± 30 mm
- SMEMA compatible

Options

- Motorized/Automatic width adjustment
- Safety interlockers

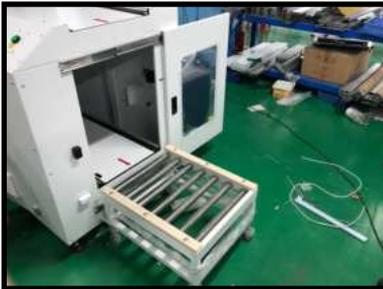

Exit magazine ramp and door with locker.

Technical Parameters

Description	These units are used for unloading PCBs out of the line . It can also heat the PCBs inside to cure them.
Capacity	Up: 2 rack; Down: 2 rack
Magazine Change Time	Approx. 30 seconds
Indexing Pitch	10, 20, 30, 40, 50, 60, 70, 80, 90, 100 mm
Power Source	AC 220V, 50/60Hz, 1 phase
Power Consumption	300W Max.
Air Pressure & Consume	4-6 bar, 10 l/min Max.

Schematic

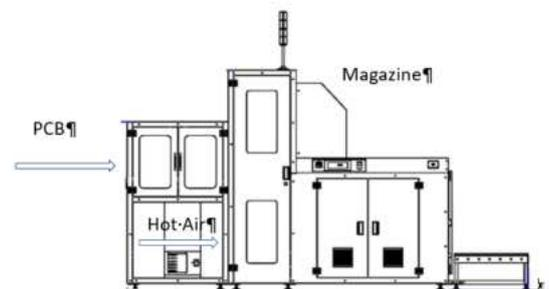

Specification

Units in mm

Size	Model	Machine Dimensions (LxWxH) in mm	Effective PCB Size (LxW) in mm	Rack Size (LxWxH) in mm	Weight (Kg)
L	WHM-511SDNTL-CH	3200x1118x1790	80x80 - 445X330	460X400X563	600

Compact Double Loader

Features

- User friendly touchscreen control
- Top & bottom pneumatic clamps to secure magazine rack
- Self diagnostic Error code display
- Puller mechanism for boards pick-up
- Safety device underneath lifter to prevent accidents
- Conveyor height 950 ± 30 mm
- SMEMA compatible
- Safety optical barriers over the magazines area

Options

- Automatic width adjustment
- Safety interlockers
- Different belt width and chain system
- 3 magazines in a line

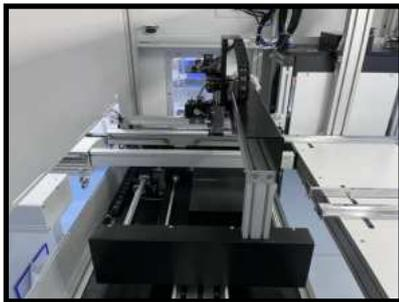

Internal shuttle

Technical Parameters

Description	These units are used for loading PCBs in to the line and allow direct access to the magazines contents.
Capacity	Left: 1 rack; Right: 1 rack
Indexing Pitch	10, 20, 30, 40, 50, 60, 70, 80, 90, 100 mm
Power Source	AC 220V, 50/60Hz, 1 phase
Power Consumption	300W Max.
Air Pressure & Consume	4-6 bar, 10 l/min Max.

Schematic

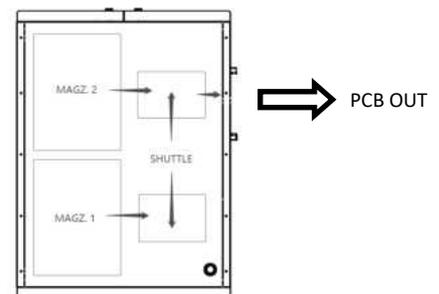

Specification

Units in mm

Size	Model	Machine Dimensions (LxWxH) in mm	Effective PCB Size (LxW) in mm	Rack Size (LxWxH) in mm	Weight (Kg)
M	WHM-327SD3TM-C	1239x1637x1682	80x80 - 330x250	355x320x563	680
L	WHM-327SD3TL-C	1239x1637x1682	80x80 - 445x330	460x400x563	680
LL	WHM-327SD3TLL-C	1409x1897x1682	80x80 - 530x390	535x460x570	720
XL	WHM-327SD3TXL-C	1409x1897x1682	80x80 - 530x460	535x530x570	720

Compact Double Unloader



Features

- User friendly touchscreen control
- Top & bottom pneumatic clamps to secure magazine rack
- Self diagnostic Error code display
- Safety device underneath lifter to prevent accidents
- Conveyor height 950 ± 30 mm
- SMEMA compatible
- Safety optical barriers over the magazines area

Options

- Automatic width adjustment
- Safety interlockers
- Different belt width and chain system
- 3 magazines in a line
- NG/OK sorting version



Magazine platform

Technical Parameters

Description	These units are used for unloading PCBs from the line and allow direct access to the magazines contents.
Capacity	Left: 1 rack; Right: 1 rack
Indexing Pitch	10, 20, 30, 40, 50, 60, 70, 80, 90, 100 mm
Power Source	AC 220V, 50/60Hz, 1 phase
Power Consumption	300W Max.
Air Pressure & Consume	4-6 bar, 10 l/min Max.

Schematic

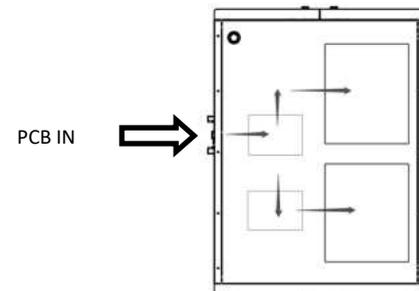

Specification

Units in mm

Size	Model	Machine Dimensions (LxWxH) in mm	Effective PCB Size (LxW) in mm	Rack Size (LxWxH) in mm	Weight (Kg)
M	WHM-328SD3TM-C	1239x1637x1682	80x80 - 330x250	355x320x563	680
L	WHM-328SD3TL-C	1239x1637x1682	80x80 - 445x330	460x400x563	680
LL	WHM-328SD3TLL-C	1409x1897x1682	80x80 - 530x390	535x460x570	720
XL	WHM-328SD3TXL-C	1409x1897x1682	80x80 - 530x460	535x530x570	720

NG/OK UNLOADER

Dual Magazine Unloader



Features

- User friendly soft touch screen control
- Top & bottom pneumatic clamps to secure magazine rack
- Automatic shuttle moves the board to the desired rack exit for NG function, or dual magazine configuration.
- Pressure regulated pusher to prevent board damage
- Conveyor height 950 ± 30mm
- SMEMA compatible

Options

- Motorized/Automatic width adjustment
- Safety interlockers
- Different belt width and chain system
- Universal type (Multiple magazine sizes)

Technical Parameters

Description	These units are used for unloading PCBs off the line, in a dual magazine, or in an NG/OK selection mode.
Capacity	Up: 2 racks; Down: 4 racks
Magazine Change Time	Approx. 30 seconds
Indexing Pitch	10, 20, 30, 40mm or specify
Power Source	AC 220V, 50/60Hz, 1 phase
Power Consumption	300W Max.
Air Pressure & Consume	4-6 bar, 10 l/min Max.

Schematic

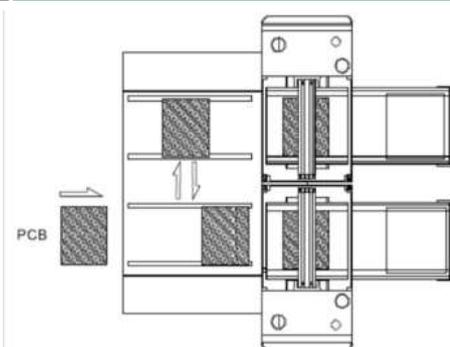

Specification

Units in mm

Machine Type	Size	Model	Machine Dimensions (LxWxH) in mm	Effective PCB Size (LxW) in mm	Rack Size (LxWxH)	Weight (Kg)
NG/OK UNLOADER	M	WHM-305SD3TM-CI	1902x1527x1683	80x80 - 330x250	355x320x563	760
	L	WHM-305SD3TL-CI	2298x1688x1683	80x80 - 445x330	460x400x563	820
	LL	WHM-305SD3TLL-CI	2683x1940x1683	80x80 - 530x390	535x460x570	870
	XL	WHM-305SD3TXL-CI	3083x2216x1683	80x80 - 530x460	535x530x570	980
DUAL MAG UN-LOADER	M	WHM-306SD3TM-CI	1902x1527x1683	80x80 - 330x250	355x320x563	760

Elevator Conveyors / Return Lines



Features

- User friendly touch screen control panel
- Fast, smooth and precise positioning (Servomotor)
- Selectable system thresholds
- Smooth and parallel conveyor adjustment (lead screw)
- Automatic width adjustment
- SMEMA compatible
- Two types: high elevator (for top return lines) and low elevator (for bottom return lines)

Options

- Safety interlockers
- Different belt width and chain system
- Wheels to move the machine easily around



Lower return line



Upper return line

Technical Parameters

Description	This unit is used to allow permanent passage across the line, or for loop-style installations.
Belt Type	Antistatic Flat Belt of 3mm width
Conveyor Speed	0.5-20m/min or specify
Power Source	AC 220V, 50/60Hz, 1 phase
Power Consumption	100 Max
Cycle time	10 sec

Schematic

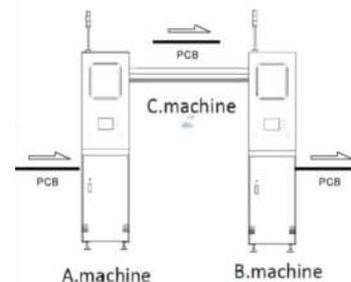

Specification

Units in mm

Size	Model	Machine Dimensions	Effective PCB Size (LxW)	Type of Return Line	Weight (Kg)
L	WHM-02624SD3T L	550x975x2608	80x80 - 445x330	Top	350
XL	WHM-02624SD3TXL	640x1035x2608	80x80 - 530x460	Top	450
L	WHM-02601SD3TL	550x1012x1982	80x80 - 445x330	Bottom	350
XL	WHM-02601SD3TXL	635x1142x1982	80x80 - 530x460	Bottom	400

Insertion Conveyor



Features

- Modular design, PLC controlled
- Stability enhanced by heavy design
- Smooth and parallel width adjustment (stainless steel screws)
- Automatic/Manual modes
- Shelf for ESD component boxes
- Light system for better inspection
- Variable speed control
- SMEMA compatible
- Conveyor height $950 \pm 30\text{mm}$

Options

- Support for Monitor
- Motorized width adjustment
- Choice of different chain transport system
- Mechanical stopper
- Foot pedal pass control

Technical Parameters

Description	This unit is used in a manual line before soldering section. For the operator to insert components manually.
Belt Type	Pin chain
Conveyor Speed	0.5-20m/min or specify
Power Source	AC 220V, 50/60Hz, 1 phase
Power Consumption	100W Max.

Schematic

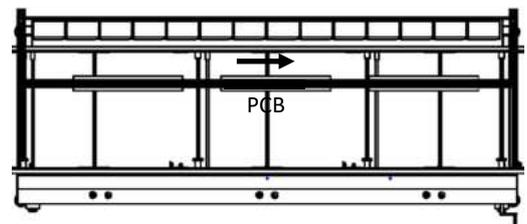

Specification

Units in mm

Size	Model	Machine Dimensions(LxWxH) in mm	Effective PCB Size (LxW) in mm	Weight (Kg)
XL	WH-S270SDNBXL-DW	2700x1019x1786	60x60 - 445X460	400

Flat Belt Conveyor



Features

- Modular design, PLC controlled
- Buzzer
- Variable speed control
- Flat belt of 500mm width
- Signal Tower

Options

- Different lengths available on demand

Technical Parameters

Description	Flat belt conveyor to transport boards after re-flow oven mesh belt, and accumulate them.
Belt Type	500mm wide flat belt
Conveyor Speed	0.5-20m/min or specify
Power Source	AC 220V, 50/60Hz, 1 phase
Power Consumption	100W MAX

Schematic

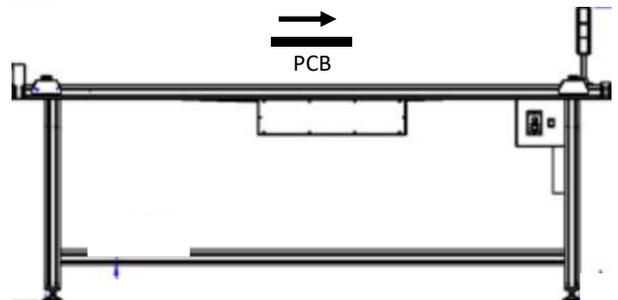

Specification

Units in mm

Model	Machine Dimensions (LxWxH) in mm	Effective PCB Size (LxW) in mm	Weight (Kg)
WH-C250SD500BXL-L	2500X795x1254	60x60-2000x490	120

PCB Cleaning Machine

Features

- Real-Time Electrostatic Monitoring System
- The system could save 30 days' monitoring data.
- User friendly touch screen control panel
- Keyence Ionizer to remove static electricity
- Pull-out design for cleaning machine
- Conveyor height 950 ± 30mm
- SMEMA compatible
- Two types on request: single side or double side

Options

- External brush with vacuum to absorb out dust
- Additional ionizers for better static elimination
- Automatic width adjustment
- Safety interlocker



The cleaning roller



Technical Parameters

Description	This unit is used to remove the foreign objects from the PCB surface. It can also eliminate the static electricity on of PCB
Belt Type	Antistatic Flat Belt of 8mm width
Cycle Time	Approx. 8 seconds
PCB Thickness	0.6-4mm
Conveyor Speed	0.5-20m/min or specify
Power Source	AC 220V, 50/60Hz, 1 phase
Power Consumption	150W Max
Air Pressure & Consume	4-6 bar, 10 l/min Max.

Schematic

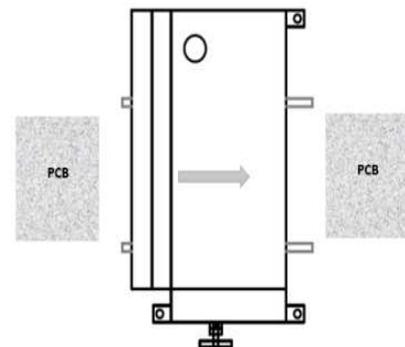

Specification

Units in mm

Type	Model	Machine Dimensions (LxWxH)	Effective PCB Size (LxW)	Weight (Kg)
Single Side	WHM-055HD3TL	650x825x1380	80x80 - 445x330	160
Single Side	WHM-055HD3TXL	650x976x1380	80x80 - 530x460	180
Double Side	WHM-056HD3TL	650x825x1380	150x80 - 445x330	180
Double Side	WHM-056HD3TXL	650x976x1380	150x80 - 530x460	200

Wave Outfeed Conveyor

Belt wave outfeed conveyor



Features

- Variable speed control
- Flat belt of 500mm width

Options

- Cooling fans on top
- Extension conveyor available on demand

Chain wave outfeed conveyor



Features

- Modular design, PLC controlled
- Variable speed control
- 3mm pin chain conveyor
- Sliding resistors on inclined section

Options

- Cooling fans on top
- Motorized width adjustment

Technical Parameters

Description	This unit is used to unload PCBs or pallets from a wave soldering machine.
Belt Type	Flat belt or chain
Conveyor Speed	0.5-20m/min or specify
Power Source	AC 220V, 50/60Hz, 1 phase
Power Consumption	100W MAX

Schematic

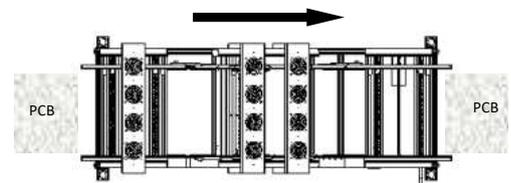

Specification

Units in mm

Type	Model	Machine Dimensions (LxWxH) in mm	Effective PCB Size (LxW) in mm	Weight (Kg)
Flat Belt	WH-C130SD500BXL	1350x685x1335	60x60-550x490	120
Chain	WH-C250SDNBXL	2500x976x1446	200x200-550x610	400

LASER MAKER RTM-450

Features

- Auto control, English Interface, Windows 10 Operation System
- Double Camera System, for fiducials and pattern verification after laser marking.
- 0.02mm print accuracy
- Could print chars, number, Logo, Barcode, QR code, etc.
- Could connect with Shopfloor/MES System
- Support PCB, FPC, Metal and other materials.
- Visual interface.
- Optional inverter function.



Operation Interface



Applications



PCB

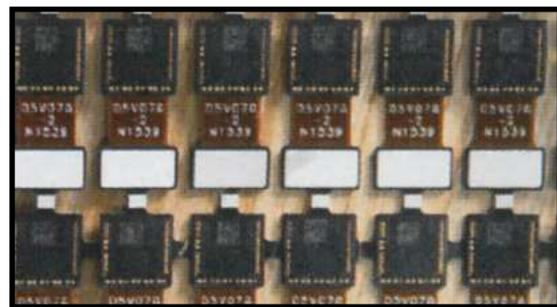

Components

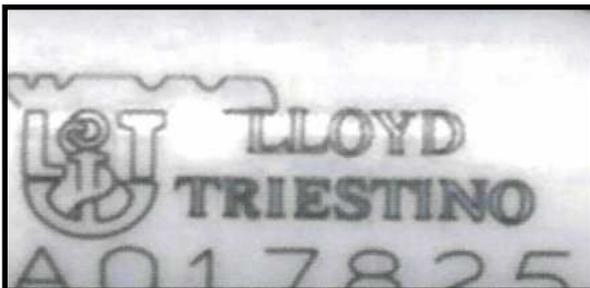

Ceramics



Plastic

Technical Parameters

Main Body

Dimensions in mm	L*W*H 900*1620*1650
Weight in Kg	650
Power Supply	Power:1500W Power Supply: 220VAC 50Hz
Air Supply	5-7Kgf/cm ² or 0.5-0.7 Mpa
Control System	PC+ Motion control+ Servo Motor
Direction	Left to Right or Right to Left
Width Adjustment	CNC Automatic width adjustment
Transfer Speed	Max 1000mm/S
X-Y Transfer Speed	1000m/s (1500mm/S Optional)
Conveyor Speed	0-3000mm/min
Accuracy	±0.02mm
Exhaust Pipe Diameter	50mm
Dust Collector	Supplied with machine

Software & Network

Operation System	Windows 10
Connections	MES, IMS, ShopFloor...
Software	EzCad2
Control OS	Self-Developed Software
Network Support	EtherNet

Environment Requirement

Temperature	0-40°C Without dew and ice
Humidity	35-85%RH Without dew and ice
Transportation and Storage	It can be stored in a 22-55 degree environment and can withstand no more than 65 degrees within 24 h.

Print Requirements

Marking Size	Single Lane	50x50~530x460mm
	Dual Lane	50x50~200x200mm
Marking Method	By moving the laser head	

Schematic

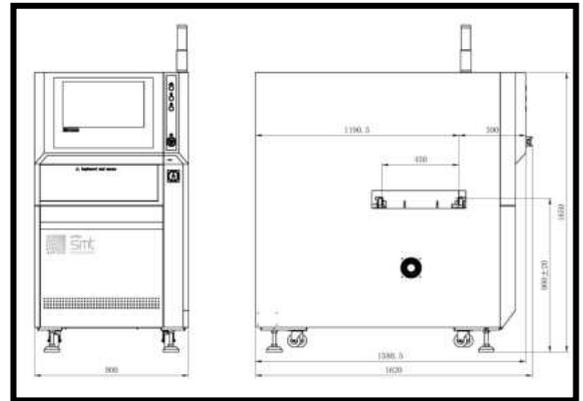

Laser Specification

Type of Laser	CO2 Laser: Wave length 10640nm
	UV Laser: Wave length 355nm
	Fiber Laser: Wave length 1064nm
CO2 Laser Power	10W/20W
Ultraviolet Laser Power	3W/5W
Fiber Laser Power	10W/20W
Min. Printing Width	CO2 Laser: 0.08mm
	Ultraviolet Laser: 0.03mm
	Fiber Laser: 0.05mm
Cooling Method	Air and Liquid Cooling
Laser Head Scanning Range	70x70mm
Laser Head Focal Length	f=100mm
Laser Head Height Adjustment	Manually ± 10mm
Printing Angle	360 degree
Location System	CCD Location
Online Barcode Reading	Yes

Dust collector



This device is designed for our laser maker, to remove the dust produced with the laser working. It has features and advantages as follows:

- Multiple filtering
- Metal frame makes it durable
- CNC controlled and digital display
- Filter failure alarm
- Noise reduction design
- Observation window to check the condition of filter
- Alloy impeller providing stability and large air volume

Barcode Scanner Conveyor

Features

- Compact equipment.
- Smallest size of the identification QR code is 2.5mm*2.5mm.
- Up to 8 barcode coordinates can be set (Standard).
- KEYENCE Barcode Reader, model SR-700 included.
- PLC and touchscreen control.
- Conveyor height 950 ± 30mm
- SMEMA compatible
- The Keyboard tray can come in white or black colors.

Options

- Double side scanner.
- MES communication
- Automatic width adjustment
- Safety interlocker



Double side barcode scan



Technical Parameters

Description	The basic function of this equipment is to scan and send barcode information to the next equipment in a fixed protocol.
Belt Type	Antistatic Flat Belt of 4mm width
Cycle Time	Depends on how many BC to read
PCB Thickness	0.6-4mm
Conveyor Speed	0.5-20m/min or specify
Power Source	AC 220V, 50/60Hz, 1 phase
Power Consumption	150W Max
Air Pressure & Consume	4-6 bar, 10 l/min Max.

Schematic

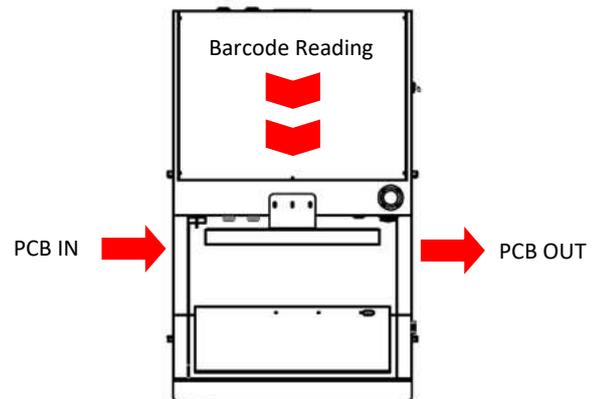

Specification

Units in mm

Type	Model	Machine Dimensions (LxWxH)	Effective PCB Size (LxW)	Weight (Kg)
Single Side	WHM-1Z700L-1G	500x980x1800	60x60 - 445x330	350
Single Side	WHM-1Z700XL-1G	700x1110x1800	60x60 - 530x460	380
Double Side	WHM-1Z700L-2G	500x980x1800	60x60 - 445x330	400
Double Side	WHM-1Z700XL-2G	700x1110x1800	60x60 - 530x460	430

Solder Ball Cleaning Machine



Features

- It removes the adhered solder balls and the dust present on the PCB surface.
- Anti-static self-made brush with outer ring.
- Servomotor speed control for high accuracy.
- Digital pressure switch to regulate vacuum pressure, with a vacuum flowmeter for the dust and solder balls absorbed.
- Cleaning method by brush mechanism + vacuum + electrostatic removal + monitoring system
- The brush mechanism and linear ionizer are installed on the XY moving system, allowing the cleaning at any position of the board, which is more accurate.

Options

- Double brush system
- Safety interlockers
- Cooling Fans
- Top side anti-static ionizer fan
- Cleaning monitor camera + display & recording
- Keyence SR-700 barcode reader + Industrial PC + MES integration

Technical Parameters

Description	This machine is used to help remove the solder balls produced after selective or wave soldering processes.
Transport Type	Chain / Rollers
Brush Material/Hardness	Nylon and anti-static composite materials/20N
PCB Thickness	0.6-4mm
Conveyor Speed	0.5-15m/min
Power Source	AC 220V, 50/60Hz, 1 phase
Power Consumption	300W Max
Air Pressure & Consume	4-6 bar, 10 l/min Max.

Schematic

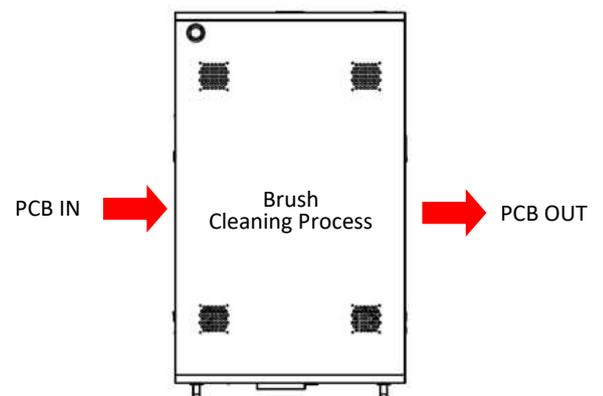

Specification

Units in mm

Model	Machine Dimensions (LxWxH)	Effective pallet Size (LxW)	Cleaning range (LxW)	Weight (Kg)
WHM-M9001SDNTXL-A	900x1447x1590	150x150 - 600x550 mm	450x460 mm	450

Automation Lines Examples

CASE 1

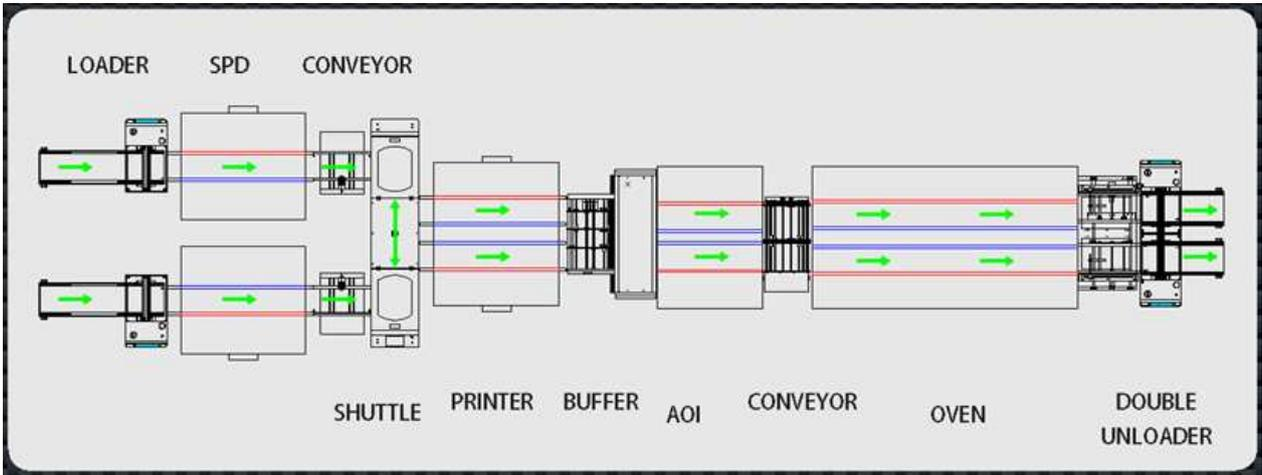

CASE 2

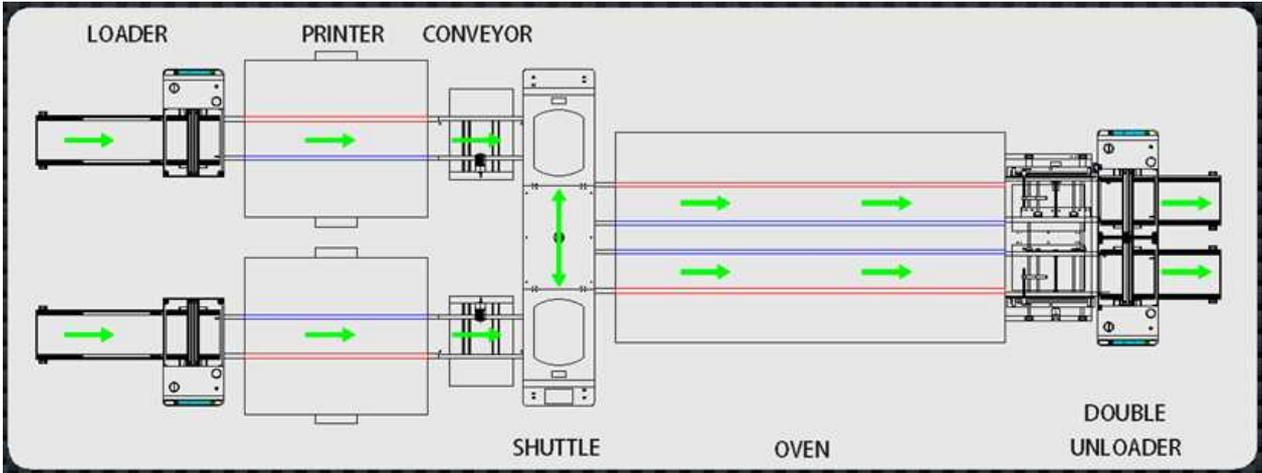

CASE 3

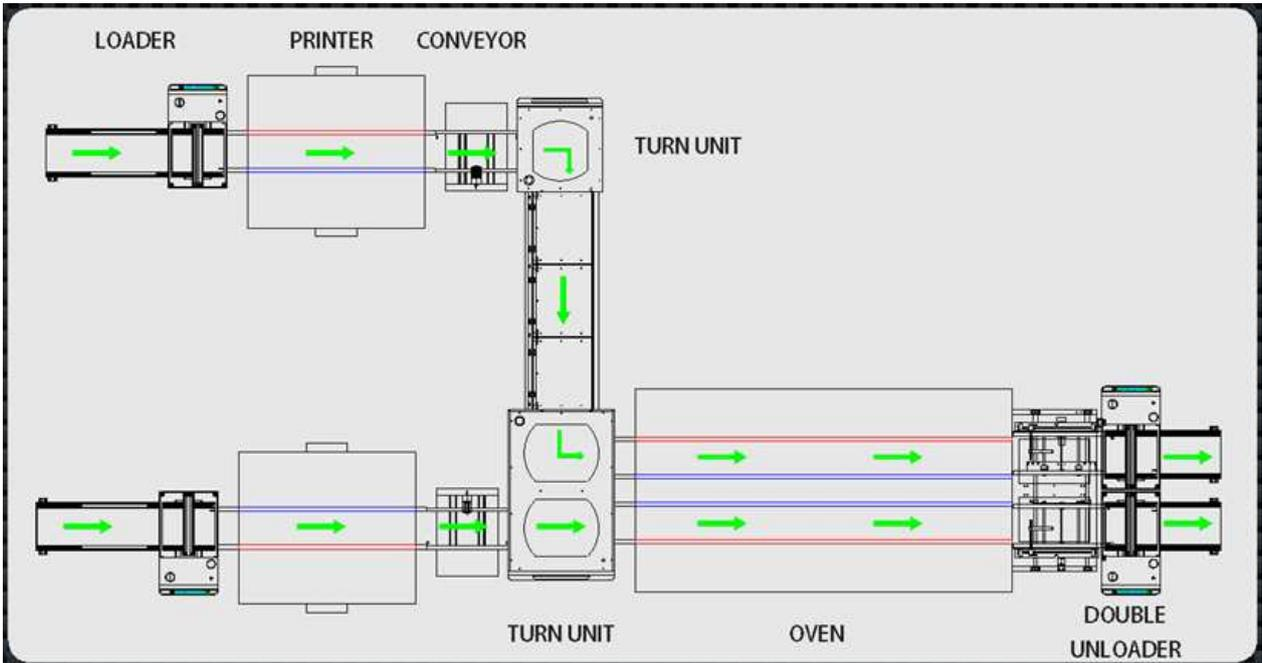

Customers World Wide

Important Clients



Quality Assurance

Product reliability is our constant goal

Research & Development

Our R&D department is committed to the integration of customer needs and the requirements of the SMT process. Our design concept is to reduce product maintenance rate, accelerate the speed of the maintenance, and improve the PCB automation process between equipment.

Quality Control

We ensure that our products are of high reliability. The implementation of the ISO9001 quality control system in our manufacturing plant is just one of the taken measures.

We perform inspections, production process controls and functional tests by qualified engineers for all our orders, plus a final quality control by a European engineer previous to any shipment world wide.



Agent Network



■ After-sale Service

We believe that support is important, and that's why we select the best companies to be our agents world wide, highly specialized enterprises which have a team of well-trained engineers that will offer maintenance and support for all the lines that we have supplied.

Very important is also the after-sales support that we supply to each of our agents, with direct communication when required, fast delivery of spare parts in case of need, and technical assistance by phone or other electronic means. We believe that a fast support at the customer's side is the answer to a successful business.



PCB Cleaning Line



Our booth at SMT Hybrid Packaging in Germany



Our conveyors at Productronica Show in Germany



Return line for selective soldering project



Our booth at Nepcon Thailand



SMT in Europe



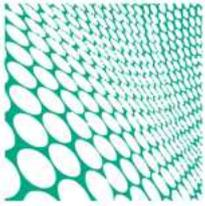

e-flex
smt
microsystems



e-Flex SMT Microsystems, Co., Ltd.

Head Office:

Rm 114, 9/F, YF Life Tower
33 Lockhart Road, Wan Chai
Hong Kong SAR, China

Tel.: +852 3529 1071

Fax: +852 3529 1070

Email: info@eflexsmt.com

www.eflexsmt.com

Financial Dept. Branch:

8/F, Golden Star Building,
20-24 Lockhart Road, Wan Chai

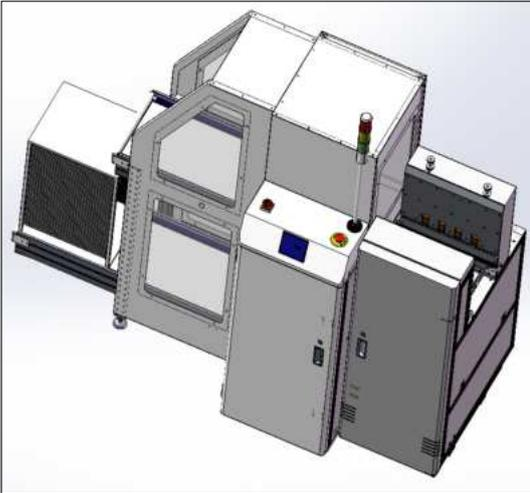
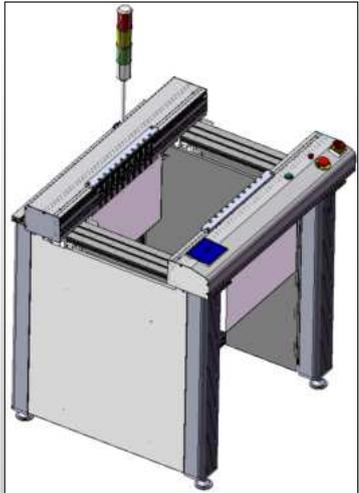
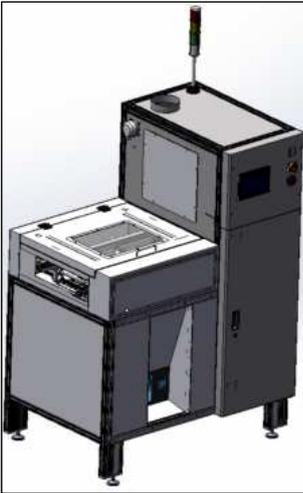
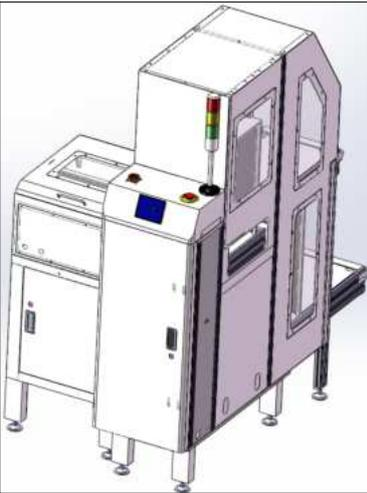
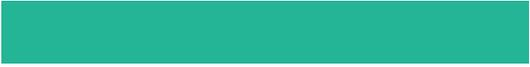

Magazine Buffer

Curing Buffer

Reject Conveyor

Loader/Destacker Combo

Follow us in

2023/24

